



VAT Vakuumventile AG
CH-9469 Haag, Schweiz

Product data sheet

Mini Vakuum gate valve, Series 012, DN 25 (ID 1")
Ordering No. 01228-KA44

Description

Flange	ISO-KF 25
Actuator	pneumatic, double acting – with solenoid valve – with position indicator
Feedthrough	Shaft feed through

Technical data

Leak rate	– Valve body – Valve seat	$< 1 \cdot 10^{-9}$ mbar ls ⁻¹ $< 1 \cdot 10^{-9}$ mbar ls ⁻¹
Pressure range		$1 \cdot 10^{-7}$ mbar to 1 bar (abs)
Differential pressure on the gate		≤ 1 bar
Differential pressure at opening		≤ 30 mbar
Conductance (molecular flow)		34 ls ⁻¹
Cycles until first service		50 000
Temperature (Maximum values: depending on operating conditions and sealing materials)	– Valve Body – Actuator – Solenoid valve – Position indicator	≤ 100 °C ≤ 80 °C ≤ 50 °C ≤ 80 °C
Heating and cooling rate		≤ 30 °C h ⁻¹
Material	– Valve Body – Gate	EN AW – 6082 (3.2315) AISI 304 (1.4301)
Seal	– Bonnet – Gate – Actuator	FKM (Viton®) FKM (Viton®), vulcanized FKM (Viton®)
Mounting position		any
Volume of pneumatic actuator		0.03 l / 0.001 ft ³
Compressed air min. – max. overpressure		4.5 – 7 bar / 65 – 100 psi
Compressed air connection		G 1/8" (1/8" NPT for USA)
Actuation time	– closing – opening	1.1 s 1.1 s
Weight		0.7 kg / 1.5 lbs

Created by: SON	Release date: 2012-12-21	1 of 2
Modified by:	Release date:	271798EA



VAT Vakuumentile AG
CH-9469 Haag, Schweiz

Product data sheet

Mini Vakuum gate valve, Series 012, DN 25 (ID 1")
Ordering No. 01228-KA44

Behavior in case of compressed air pressure drop	– Valve closed – Valve open	valve remains closed undefined
Behavior in case of power failure	– Valve closed – Valve open	valve remains closed valve closes

Electrical connections

Solenoid valve

Type	4/2-way
Voltage	Defined by order

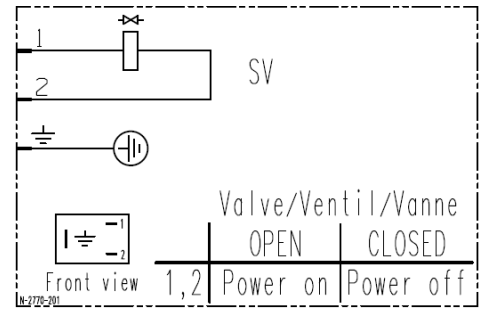

Wiring diagram

Position indicator

Voltage	≤ 250 V AC	≤ 50 V AC / DC
Current max.	5.0 A	≤ 0.5 A
Power	Max. 10 W	

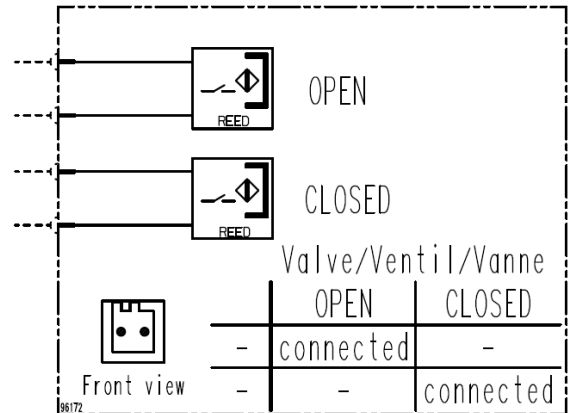

Wiring diagram