

ATM Door LINVAT

Series 070

This manual is valid for the following product ordering numbers:

070__-U_24/44-...

070__-V_24/44-...

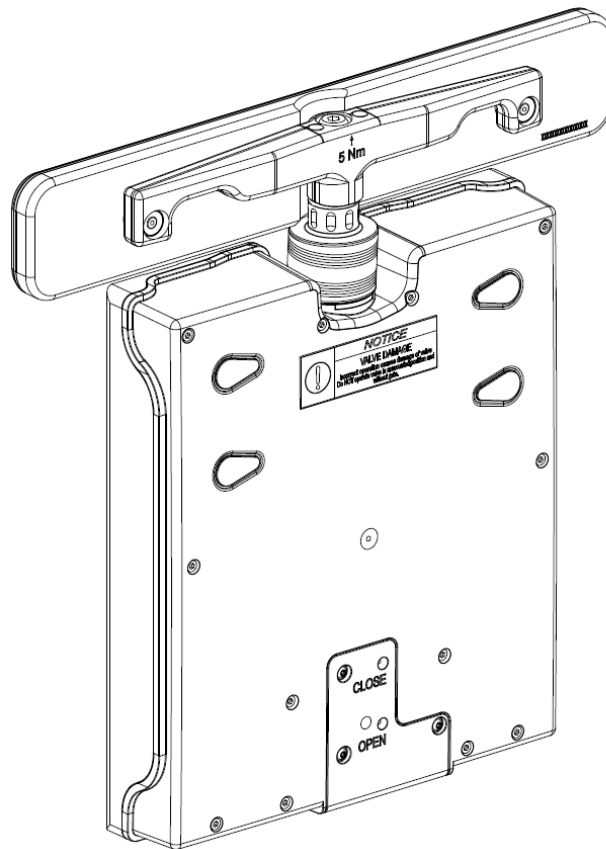

Sample picture

Imprint

Manufacturer VAT Vakuumventile AG, CH-9469 Haag, Switzerland

Website: www.vatvalve.com
Phone: +41 81 771 61 61
Fax: +41 81 771 48 30
Email: CH@vatvalve.com

Publisher VAT Vakuumventile AG, CH-9469 Haag, Switzerland

Editor VAT Vakuumventile AG, CH-9469 Haag, Switzerland

Print VAT Vakuumventile AG, CH-9469 Haag, Switzerland

Copyright © VAT Vakuumventile AG 2023

No part of these instructions may be reproduced in any way (photocopies, microfilms or any other reproduction processes) nor may it be manipulated with electronic systems, duplicated or distributed without written permission from VAT. Offenders are liable to pay damages.

The original VAT firmware and updated state of the art versions of the VAT firmware are intended for use with VAT products. The VAT firmware contains a limited, time unlimited user license. The VAT firmware may not be used for purposes other than those intended nor is it permitted to make copies of the VAT firmware. In particular, it is strictly forbidden to give copies of the VAT firmware to other people.

The use of trade names, brand names, trademarks, etc. in these Instructions does not entitle third parties to consider these names to be unprotected and to use them freely. This is in accordance with the meaning of the laws and acts covering brand names and trademarks.

Contents

1	Description of product	4
1.1	Identification of product.....	4
1.2	Use of product.....	4
1.3	Used abbreviations	4
1.4	Related documents	4
1.5	Important information	4
1.6	Technical data.....	4
2	Safety	5
2.1	Compulsory reading material.....	5
2.2	Danger levels	5
2.3	Personnel qualifications	6
2.4	Safety labels.....	6
3	Design and Function	7
3.1	Design	7
3.2	Function	8
4	Installation	9
4.1	Unpacking	9
4.2	Installation into the system.....	10
4.3	Compressed air connection	12
4.4	Electrical connection	12
4.5	Initial operation.....	13
5	Operation	14
5.1	Normal operation.....	15
5.2	Operation under increased temperature.....	15
5.3	Behavior in case of air pressure drop	15
5.4	Behavior in case of power failure.....	15
5.5	Trouble shooting	16
6	Maintenance	17
6.1	Maintenance intervals	17
6.2	Required tools	17
6.3	Replacement of gate	18
6.4	Replacement of gate with O-ring	20
7	Repairs	21
8	Dismounting and Storage	22
8.1	Dismounting	23
8.2	Storage.....	23
9	Packaging and Transport	24
9.1	Packaging	25
9.2	Transport.....	25
10	Disposal	26
11	Spare parts	27

1 Description of product

1.1 Identification of product

The serial number and order number are fixed on the product directly or by means of an identification plate.



1.2 Use of product

Use product for clean and dry vacuum applications only. Other applications are only allowed with the written permission of VAT.

1.3 Used abbreviations

Abbreviation	Description
ATM	Atmospheric
CDA	Compressed dry air

Table 1-1

1.4 Related documents

- Product data sheet
- Dimensional drawing

1.5 Important information



This symbol points to a very important statement that requires particular attention.

Example:



VAT disclaims any liability for damages resulting from inappropriate packaging.

1.6 Technical data

See product data sheet and dimensional drawing.

2 Safety

2.1 Compulsory reading material

Read this chapter prior to performing any work with or on the product. It contains important information that is significant for your own personal safety. This chapter must have been read and understood by all persons who perform any kind of work with or on the product during any stage of its serviceable life.

	NOTICE
	<p>Lack of knowledge Failing to read this manual may result in property damage. Firstly, read manual.</p>





These Installation, Operating & Maintenance Instructions are an integral part of a comprehensive documentation belonging to a complete technical system. They must be stored together with the other documentation and accessible for anybody who is authorized to work with the system at any time.

2.2 Danger levels



	⚠ DANGER
	<p>High risk Indicates a hazardous situation which, if not avoided, will result in death or serious injury.</p>

	⚠ WARNING
	<p>Medium risk Indicates a hazardous situation which, if not avoided, could result in death or serious injury.</p>

	⚠ CAUTION
	<p>Low risk Indicates a hazardous situation which, if not avoided, may result in minor or moderate injury.</p>

	NOTICE
	<p>Command Indicates a hazardous situation which, if not avoided, may result in property damage.</p>

2.3 Personnel qualifications

	 WARNING
	<p>Unqualified personnel Inappropriate handling may cause serious injury or property damage. Only qualified personnel are allowed to carry out the described work.</p>

2.4 Safety labels

Label	Part No.	Location on product
	T-9001-155	Optional on the outside of the actuator

Table 2-1

3 Design and Function

3.1 Design

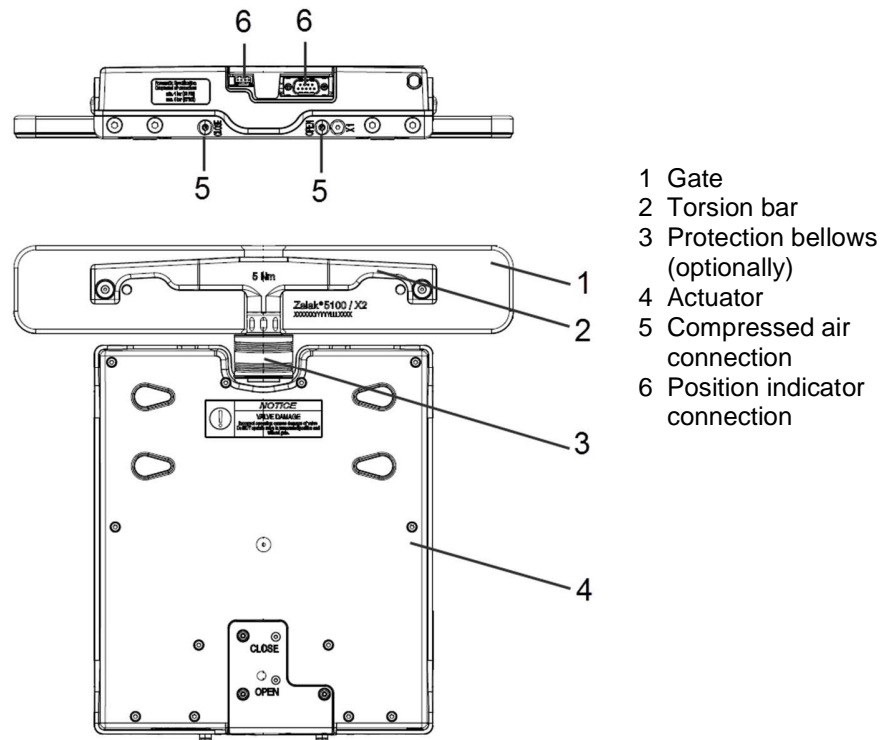

Figure 3-1

3.2 Function

The stroke of the two pneumatic cylinders implements two different movements of the plate. The first movement is the vertical stroke. The second movement is the horizontal stroke. The horizontal movement is driven from the same pneumatic cylinder as the vertical stroke but activated by a linear guidance.

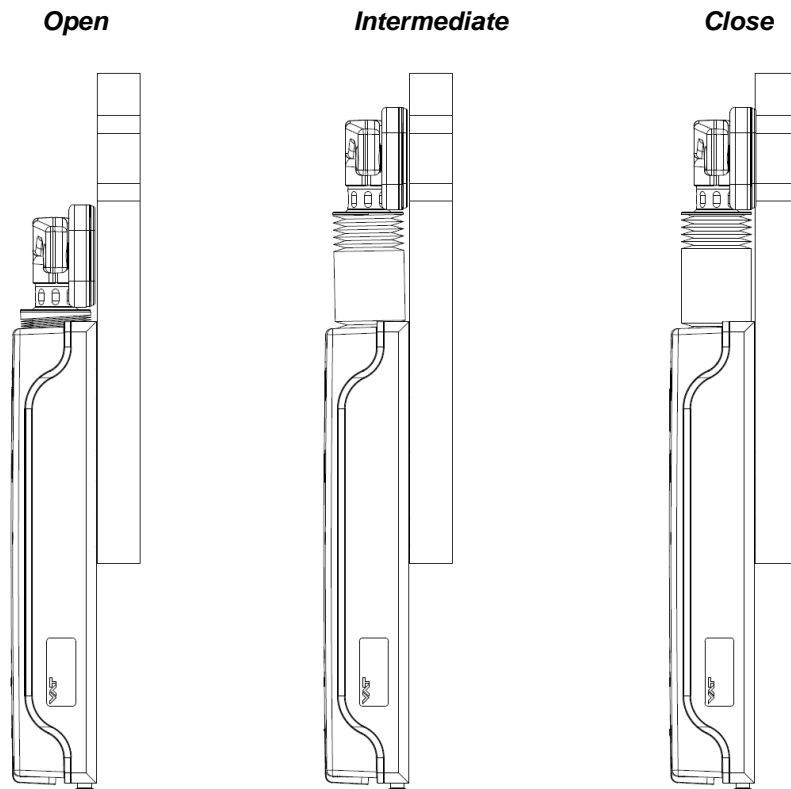



Figure 3-2

4 Installation

	⚠ WARNING
	Unqualified personnel Inappropriate handling may cause serious injury or property damage. Only qualified personnel are allowed to carry out the described work.

	NOTICE
	Insufficient stability Product will get damaged if it is not stabilized. Assistant staff required to lift and stabilize the product during mounting.

4.1 Unpacking



- Make sure that the supplied product is in accordance with your order.
- Inspect the quality of the supplied product visually. If it does not meet your requirements, please contact VAT immediately.
- Store the original packaging material. It may be useful if the product must be returned to VAT.

1. Cut plastic straps and open the transport box.



Remove plastic bag in a cleanroom only.

2. Open the plastic bag to unpack gate and actuator.

	NOTICE
	Sensitive product Product will get damaged if not handled carefully. Handle product with care: Do not touch solid objects when lifting the product and place it down slowly and gently.

3. Place products on a clean surface.

4.2 Installation into the system

	⚠ WARNING
	<p>Hazardous components</p> <p>Parts, loaded springs, air cushions etc. may move or release a movement and cause serious injury.</p> <p>Do not connect or supply electrical power and compressed air before the product is completely mounted in the system.</p>

	NOTICE
	<p>Contamination</p> <p>Product may get contaminated.</p> <p>Always wear cleanroom gloves when handling the product.</p>

	NOTICE
	<p>Insufficient stability</p> <p>Product may get damaged when actuated at this stage.</p> <p>Do not operate before product is installed completely into the vacuum system.</p>

	NOTICE
	<p>Wrong tightening torque</p> <p>Door and screws may get damaged.</p> <p>Use tightening torque according to the size of the screws.</p>



- Make sure that sealing surfaces of the door and the chamber are undamaged. Mount door to a clean system only.
- Make sure that dimensions and tolerances specified on the dimensional drawing are strictly met.

1. Mount actuator onto the chamber, use the existing fixation screws (1), see «Figure 4-1».



Location of screws depends on mounting position. See «Figure 4-1» on page 11.

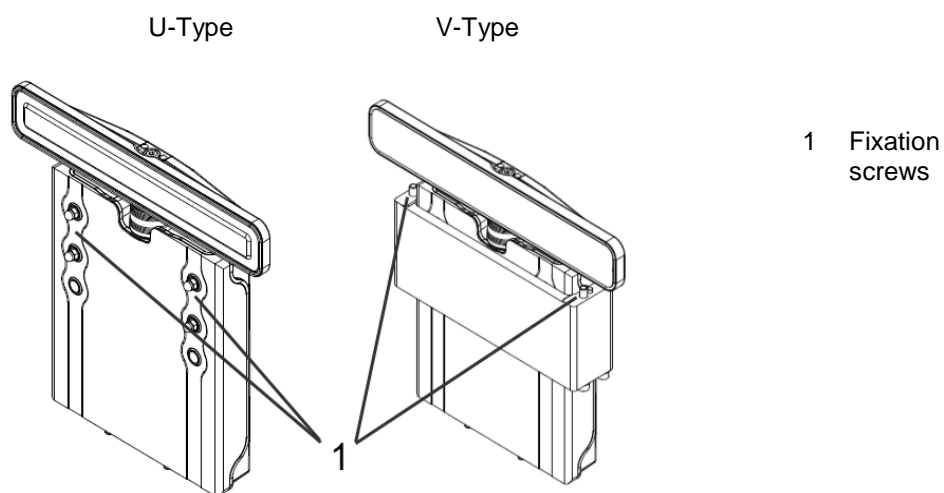

Figure 4-1



Apply torque as specified on the dimensional drawing.
Close the cap from the screw access point properly afterwards.

4.3 Compressed air connection

	WARNING
	<p>Product in open position Risk of injury when compressed air is connected to the product. Connect compressed air only when:</p> <ul style="list-style-type: none"> – product is installed to the vacuum system – moving parts cannot be touched

Use clean, dry or slightly oiled air only.

Admissible air pressure range, see product data sheet.

1. Connect compressed air according to the product data sheet and dimensional drawing.



4.4 Electrical connection

	WARNING
	<p>Product in open position Risk of injury when product is put into operation. Keep human body parts away from movable parts.</p>

	NOTICE
	<p>Wrong voltage Electrical components may get damaged. Supply electrical components with the correct voltage.</p>

1. Connect position indicator according to the product data sheet and dimensional drawing.

4.5 Initial operation

 WARNING	
	<p>Movable parts Human body parts may get jammed and severely injured. Keep human body parts away from movable parts.</p>





L-movement requires initializing of compressed air system. The door command must be set **to open at first**. This will pressurize the pneumatic system and ensure the proper L-movement during the following closing cycles.

1. Open the door.
2. Close the door.

5 Operation

	⚠ WARNING
	<p>Unqualified personnel Inappropriate handling may cause serious injury or property damage. Only qualified personnel are allowed to carry out the described work.</p>

	⚠ WARNING
	<p>Movable parts Human body parts may get jammed and severely injured. Do not operate before product is installed completely into the vacuum system. Until actuation of the door keep human body parts away from movable parts.</p>

	NOTICE
	<p>Valve Damage Incorrect operation causes damage of valve. Do NOT operate valve in unmounted position and without gate.</p>



During operation of the ATM door the pneumatic cylinders move the gate. There are small gaps with danger of injury, see «Figure 5-1». Take appropriate measures to avoid possible human injury. Do not insert body parts through door opening during operation of door.

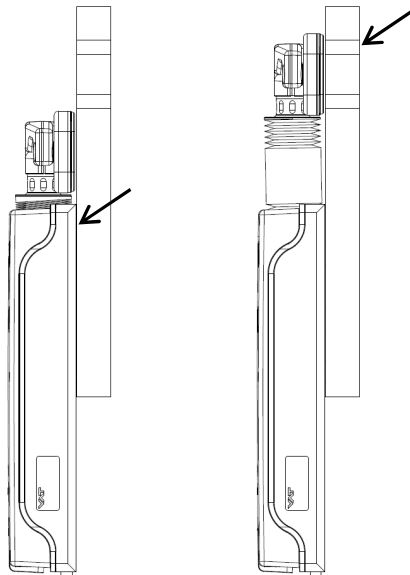

Figure 5-1

5.1 Normal operation

The door opens and closes pneumatically.

5.2 Operation under increased temperature

Maximum allowed temperature, see product data sheet.

5.3 Behavior in case of air pressure drop

See product data sheet.



L-movement requires initializing of compressed air system. The door command must be set **to open at first**. This will pressurize the pneumatic system and ensure the proper L-movement during the following closing cycles.



Proper function of internal nonreturn valve depends on speed of air pressure drop. Slow pressure drop in air supply will not trigger the nonreturn valve, therefore the position of the door will be undefined at loss of compressed air pressure.

1. Open the door.
2. Close the door.

5.4 Behavior in case of power failure

Depending on customer's installation.

5.5 Trouble shooting

Failure	Check	Action	See
Leak at gate	Check seals and sealing surfaces	Clean sealing surfaces	Product data sheet
	Damage of gate	Replace gate	«6.3 Replacement of gate»
	Seal compression of gate	Check compressed air	Product data sheet and dimensional drawing
Door cannot be operated	Connection of air lines	Check compressed air lines	Product data sheet and dimensional drawing
	Connection of power	Check power lines	Product data sheet and dimensional drawing
Gate slides at chamber wall	Installation and initial command	<ol style="list-style-type: none"> 1. Move door to open position 2. Attach door to chamber 3. Connect air to “OPEN”-port” only. 4. Block port “P” so no air can leave this port 5. Connect air tubing to “P-port” and apply CDA to this port 6. Move door to “CLOSED”-position 	Product data sheet and dimensional drawing
	Compressed air	Check compressed air pressure, requirement: See Product Data Sheet	
	Air tubing	Check correct length and diameter of compressed air supply tubing.	
	Connection of air lines	Check compressed air lines	

Table 5-1

If you need any further information, please contact one of our service centers. You will find the addresses on our website www.vatvalve.com.

6 Maintenance

	<p style="text-align: center;">⚠ WARNING</p> <p>Unqualified personnel Inappropriate handling may cause serious injury or property damage. Only qualified personnel are allowed to carry out the described work.</p>
	<p style="text-align: center;">⚠ WARNING</p> <p>Hazardous components Human body parts may get jammed and severely injured. Before starting maintenance: – disconnect compressed air supply – disconnect electrical power supply</p>
	<p style="text-align: center;">⚠ WARNING</p> <p>Movable parts Human body parts may get jammed and severely injured. Keep human body parts away from movable parts.</p>

6.1 Maintenance intervals

Under clean operating conditions the product does not require any maintenance during specified lifetime.



- Influences from the process may require more frequent maintenance.
- If the door has reached the specified life cycle – see product data sheet – we recommend a general overhaul by VAT. Please contact one of our service centers. You will find the contact data on our website www.vatvalve.com.

6.2 Required tools

- Convenience tool; see «Table 11-1» on page 27
- Allen wrench size 5
- Torque wrench 5 Nm
- Cleanroom wiper soaked with alcohol (2% methyl ethyl ketone)
- O-Ring removal tool; see «Table 11-1» on page 27

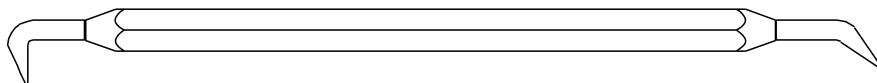





Figure 6-1

6.3 Replacement of gate

	<p style="text-align: right;">NOTICE</p> <p>Wrong tightening torque Door body and screws may get damaged. Use tightening torque according to size of the screws.</p>
	<p style="text-align: right;">NOTICE</p> <p>Contamination Product may get contaminated. Always wear cleanroom gloves when handling the product.</p>
	<p style="text-align: right;">NOTICE</p> <p>Inappropriate tools Sealing surfaces may get damaged. Do not use sharp-edged tools.</p>

1. Vent chambers.
2. Open the door.
3. Disconnect electrical power supply.
4. Disconnect compressed air supply.
5. Loosen the screw for the gate (2), use convenience tool (1), see «Figure 6-2» on page 19.
6. Grasp the gate (2), by using the convenience tool (1) into the M8 thread, see «Figure 6-2» on page 19.
7. Remove the gate (2) carefully, if necessary wiggle gently, use convenience tool (1), see «Figure 6-2» on page 19.

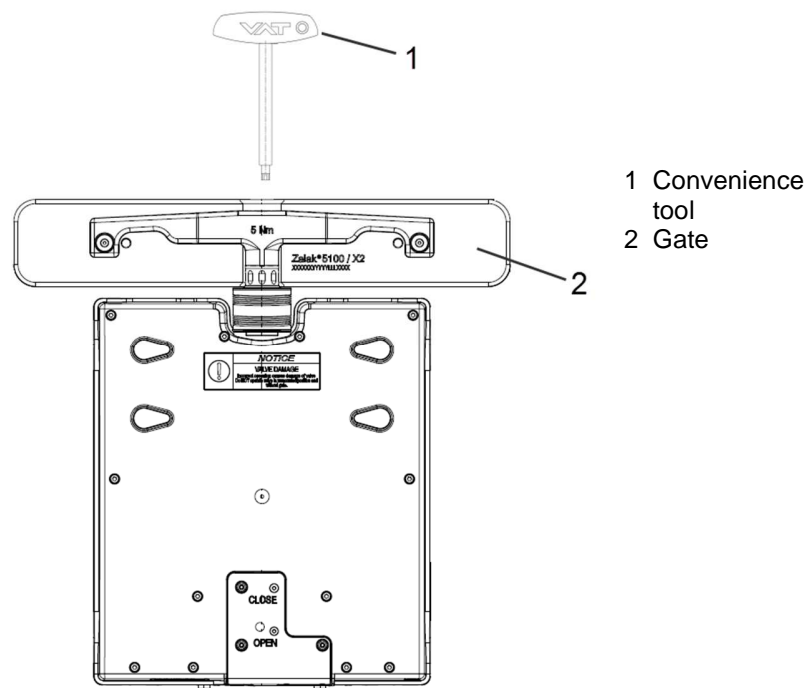





Figure 6-2

8. Exchange gate with a new gate.
9. Grasp a new gate (2) carefully, use the convenience tool (1).
10. Install the new gate (2) carefully, use the convenience tool (1).
11. Tighten the screw for the gate (2) with a torque of 5 Nm, use torque wrench.
12. Connect compressed air supply.
13. Connect electrical power supply.

Door is ready for use.

6.4 Replacement of gate with O-ring

	NOTICE
	Wrong tightening torque Door body and screws may get damaged. Use tightening torque according to size of the screws.
	NOTICE
	Contamination Product may get contaminated. Always wear cleanroom gloves when handling the product.
	NOTICE
	Inappropriate tools Sealing surfaces may get damaged. Do not use sharp-edged tools.

1. Perform steps 1 to 7 of chapter «Replacement of gate» on page 18.
2. Carefully remove gate O-ring (3) with an O-ring removal tool from gate (3), see «Figure 6-3».

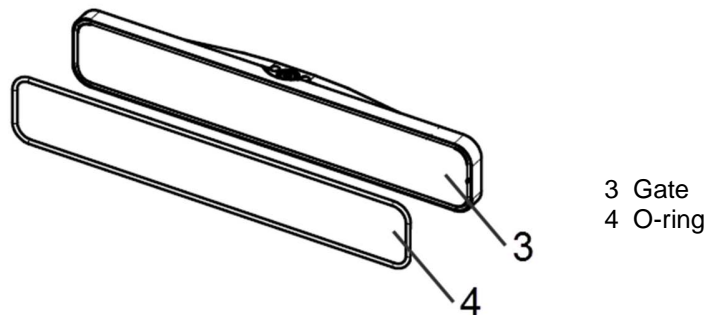

Figure 6-3

3. Clean the O-ring groove on the gate (3) with cleanroom wiper.
4. Carefully install the new gate O-ring (4).
5. Perform steps 9 to 12 of chapter «Replacement of gate» on page 18.



Door is ready for use.

7 Repairs

Repairs may only be carried out by the VAT service staff. In exceptional cases, the customer is allowed to carry out the repairs, but only with the prior consent of VAT.

Please contact one of our service centers. You will find the addresses on our website www.vatvalve.com.

8 Dismounting and Storage

	<p style="text-align: center;">⚠ WARNING</p> <p>Unqualified personnel Inappropriate handling may cause serious injury or property damage. Only qualified personnel are allowed to carry out the described work.</p>
	<p style="text-align: center;">⚠ WARNING</p> <p>Hazardous components Human body parts may get jammed and severely injured. Before dismounting the product: – disconnect compressed air supply – disconnect electrical power supply</p>
	<p style="text-align: center;">⚠ WARNING</p> <p>Movable parts Human body parts may get jammed and severely injured. Keep human body parts away from movable parts.</p>
	<p style="text-align: center;">NOTICE</p> <p>Contamination Product may get contaminated. Always wear cleanroom gloves when handling the product.</p>

8.1 Dismounting

	NOTICE
	<p>Sensitive product Product will get damaged if not handled carefully. Handle product with care: Do not touch solid objects when lifting the product and place it down slowly and gently.</p>

1. Open the door.
2. For dismounting the door follow the steps of chapter «4 Installation», however in reverse order.
Pay attention to the safety instructions!

8.2 Storage

	NOTICE
	<p>Wrong storage Inappropriate temperatures and humidity may cause damage to the product. Door must be stored at: – relative humidity between 10% and 70% – temperature between +10 °C and +50 °C – non-condensing environment</p>

	NOTICE
	<p>Inappropriate packaging Product may get damaged if inappropriate packaging material is used. Always use the original packaging material and handle product with care.</p>

1. Clean / decontaminate product.
2. Cover the gate plate with protective foil.
3. Pack product appropriately by using the original packaging material.

9 Packaging and Transport

	⚠ WARNING
	Unqualified personnel Inappropriate handling may cause serious injury or property damage. Only qualified personnel are allowed to carry out the described work.

	⚠ WARNING
	Harmful substances Risk of injury in case of contact with harmful substances. Remove harmful substances (e. g. toxic, caustic or microbiological ones) from valve before you return the valve to VAT.

	NOTICE
	Inappropriate packaging Product may get damaged if inappropriate packaging material is used. Always use the original packaging material and handle product with care.



- When returning products to VAT, please fill out the VAT form «Declaration of Chemical Contamination» and send it to VAT in advance. The form can be downloaded from our website www.vatvalve.com.
- If products are radioactively contaminated, the VAT form «Contamination and Radiation Report» must be filled out. Please contact VAT in advance.
- If products are sent to VAT in contaminated condition, VAT will carry out the decontamination procedure at the customer's expense.

9.1 Packaging

1. Cover the gate with protective foil.
2. Pack product appropriately by using the original packaging material.



VAT disclaims any liability for damages resulting from inappropriate packaging.

9.2 Transport

NOTICE	
	<p>Inappropriate packaging Product may get damaged if inappropriate packaging material is used. Always use the original packaging material and handle product with care.</p>



VAT disclaims any liability for damages resulting from inappropriate packaging.

10 Disposal

	⚠ WARNING	
	Harmful substances	

Environmental pollution.
Discard products and parts according to the local regulations.

	NOTICE
	<p>Non-original spare parts</p> <p>Non-original spare parts may cause damage to the product. Use original spare parts from VAT only.</p>



- Please specify the serial number of the product when you place an order for spare parts; see chapter «1.1 Identification of product». This is to ensure that the appropriate spare parts are supplied.
- VAT makes a difference between spare parts that may be replaced by the customer and those that need to be replaced by the VAT service staff.
- «Table 11-1» only contains spare parts that may be replaced by the customer. If you need any other spare parts, please contact one of our service centers. You will find the addresses on our website www.vatvalve.com.

Description	Part No.	Quantity per valve	Maintenance procedure see chapter
Convenience tool	239582	1	«6.3 Replacement of gate»
Gate complete	on request	1	«6.3 Replacement of gate»
O-ring removal tool	234859	1	«6.2 Required tools»

Table 11-1