

Pump-out port system

Series 23

DN 16–40 mm (I. D. $\frac{5}{8}$ " – $1\frac{1}{2}$ ")

This manual is valid for the following product ordering number/s:

23024-KA01-....., 23024-KEPS-.....

23028-KA01-....., 23028-KEPS-.....

23032-KA01-....., 23032-KEPS-.....

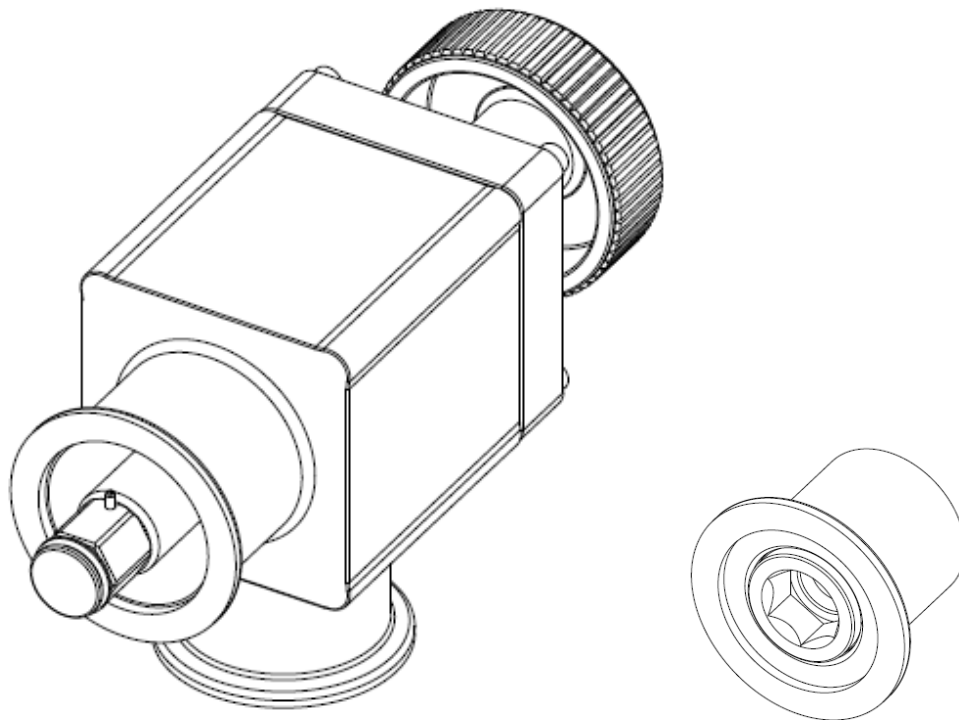

Sample picture

Imprint

Manufacturer VAT Vakuumventile AG, CH-9469 Haag, Switzerland

Website: www.vatvalve.com
Phone: +41 81 771 61 61
Fax: +41 81 771 48 30
Email: CH@vatvalve.com

Publisher VAT Vakuumventile AG, CH-9469 Haag, Switzerland

Editor VAT Vakuumventile AG, CH-9469 Haag, Switzerland

Print VAT Vakuumventile AG, CH-9469 Haag, Switzerland

Copyright © VAT Vakuumventile AG 2018

No part of these instructions may be reproduced in any way (photocopies, microfilms or any other reproduction processes) nor may it be manipulated with electronic systems, duplicated or distributed without written permission from VAT. Offenders are liable to pay damages.

The original VAT firmware and updated state of the art versions of the VAT firmware are intended for use with VAT products. The VAT firmware contains a limited, time unlimited user license. The VAT firmware may not be used for purposes other than those intended nor is it permitted to make copies of the VAT firmware. In particular, it is strictly forbidden to give copies of the VAT firmware to other people.

The use of trade names, brand names, trademarks, etc. in these Instructions does not entitle third parties to consider these names to be unprotected and to use them freely. This is in accordance with the meaning of the laws and acts covering brand names and trademarks.

Contents

1	Description of product.....	4
1.1	Identification of product.....	4
1.2	Use of product.....	4
1.3	Related documents.....	4
1.4	Technical data.....	4
2	Safety	5
2.1	Compulsory reading material.....	5
2.2	Danger levels	5
2.3	Personnel qualifications.....	6
2.4	Safety labels.....	6
3	Design and Function.....	7
3.1	Design.....	7
3.2	Function	7
4	Installation	8
4.1	Unpacking	8
4.2	Installation into the system.....	9
4.2.1	Installation of pump-out port	10
4.2.2	Installation of valve mechanism	10
4.2.3	Connection Lines.....	11
4.2.4	Admissible forces and bending moments	11
5	Operation	12
5.1	Description	134
5.2	Opening the pump-out port.....	13
5.3	Closing the pump-out port	13
5.4	Trouble shooting.....	13
6	Maintenance	14
6.1	Maintenance intervals.....	15
6.2	Required tools	15
6.3	Cleaning the valve mechanism	16
6.4	Cleaning the pump-out port	17
7	Repairs	19
8	Dismounting and Storage.....	20
8.1	Dismounting	20
8.2	Storage	22
9	Packaging and Transport	23
9.1	Packaging	24
9.2	Transport.....	24
10	Disposal	25
11	Spare parts	26
12	Appendix.....	27

1 Description of product

1.1 Identification of product

The fabrication number and order number are fixed on the product directly or by means of an identification plate.



1.2 Use of product

Use product for clean and dry vacuum applications only. Other applications are only allowed with the written permission of VAT.

1.3 Related documents

- Product data sheet
- Dimensional drawing

1.4 Technical data

See product data sheet and dimensional drawing.

2 Safety

2.1 Compulsory reading material

Read this chapter prior to performing any work with or on the product. It contains important information that is significant for your own personal safety. This chapter must have been read and understood by all persons who perform any kind of work with or on the product during any stage of its serviceable life.

	NOTICE
	<p>Lack of knowledge Failing to read this manual may result in property damage. Firstly, read manual.</p>





These Installation, Operating & Maintenance Instructions are an integral part of a comprehensive documentation belonging to a complete technical system. They must be stored together with the other documentation and accessible for anybody who is authorized to work with the system at any time.

2.2 Danger levels



	⚠ DANGER
	<p>High risk Indicates a hazardous situation which, if not avoided, will result in death or serious injury.</p>

	⚠ WARNING
	<p>Medium risk Indicates a hazardous situation which, if not avoided, could result in death or serious injury.</p>

	⚠ CAUTION
	<p>Low risk Indicates a hazardous situation which, if not avoided, may result in minor or moderate injury.</p>

	NOTICE
	<p>Command Indicates a hazardous situation which, if not avoided, may result in property damage.</p>

2.3 Personnel qualifications

	 WARNING
	<p>Unqualified personnel Inappropriate handling may cause serious injury or property damage. Only qualified personnel are allowed to carry out the described work.</p>

2.4 Safety labels



Label	Part No.	Location on valve
	T-9001-155	On protective covers of flanges
	253198	On valve body or actuators

Table 2-1

3 Design and Function

3.1 Design

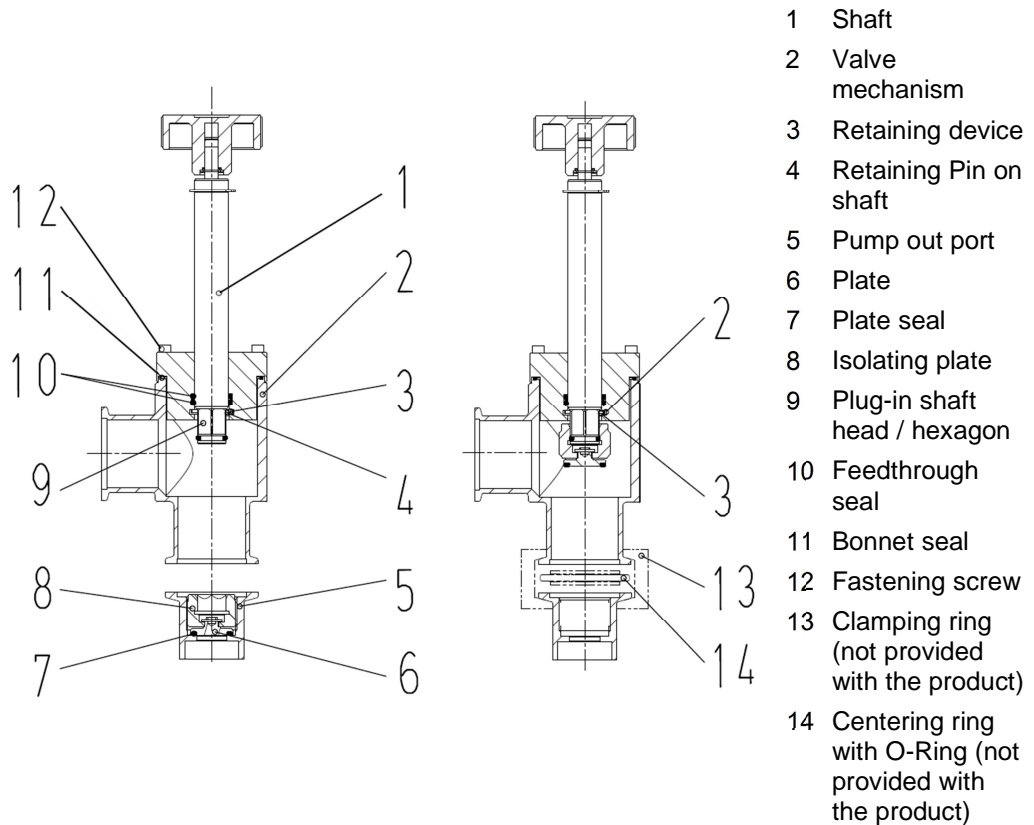

Figure 3-1

3.2 Function

The valve mechanism (2) and pump-out port (5) enable hermetical sealing of evacuated vessels or gas-filled containers without atmospheric air entering the container or vessel. Both devices can also be used to open the pump-out port (5) and hence the container, again excluding atmospheric air.

The valve mechanism (2) is demountable and can be used to close and open any number of pump-out ports of the same nominal width (DN)

Please handle the connection flanges of valve mechanism (2) and pump-out port (5) carefully and apply a protective cover when unused.

4 Installation

	⚠ WARNING
	<p>Unqualified personnel Inappropriate handling may cause serious injury or property damage. Only qualified personnel are allowed to carry out the described work.</p>

4.1 Unpacking



- Make sure that the supplied products are in accordance with your order.
- Inspect the quality of the supplied products visually. If it does not meet your requirements, please contact VAT immediately.
- Store the original packaging material. It may be useful if products must be returned to VAT.



Remove the protective covers from the valve mechanism (2) and pump-out port (5) only at the moment when the component is being installed into the system. Keep unprotected sealing surfaces clean and do not damage them..

4.2 Installation into the system

	<p style="text-align: center;">⚠ DANGER</p> <p>Overpressure in the vacuum system >1 bar Injury caused by released parts and harm caused by escaping process gases can result if clamps are opened while the vacuum system is pressurized. Do not open any clamps while the vacuum system is pressurized. Use the type of clamps which are suited to overpressure.</p>
	<p style="text-align: center;">⚠ DANGER</p> <p>Overpressure in the vacuum system >2.5 bar KF flange connections with elastomer seals (e.g. O-rings) cannot withstand such pressures. Process media can thus leak and possibly damage your health. Use O-rings provided with an outer centering ring.</p>
	<p style="text-align: center;">⚠ CAUTION</p> <p>Valve openings Human body parts may get jammed and severely injured. Do not connect or supply electrical power and compressed air before the product is completely mounted in the system.</p>
	<p style="text-align: center;">⚠ CAUTION</p> <p>Hot surfaces Risk of burning when touching hot surfaces. Take safety measures in order that the valve cannot be touched during operation. Ensure air circulation of coil.</p>
	<p style="text-align: center;">NOTICE</p> <p>Contamination Product may get contaminated. Always wear cleanroom gloves when handling the product.</p>
	<p style="text-align: center;">NOTICE</p> <p>Inappropriate tools Sealing surfaces may get damaged. Do not use sharp-edged tools.</p>

1. Check and carefully clean sealing surfaces of valve flanges and counter flanges.

2. Install valve mechanism (2) with pump-out port (5) appropriate for ISO-KF flanges according the specification of «Table 4-1» on page 11 into account.

4.2.1 Installation of pump-out port

Valve mechanism (2) and pump-out port (5) can be used in any desired position.

1. Remove the protective lids.
2. Unscrew the isolating plate (8).
3. Weld the body of the pump-out port (5) (small flange with tubulation) to the vessel or container.



The body of the pump-out port (5) must be welded by the lower edge of the tubulation only, to prevent distortion of the plate seal (7) sealing surface.

4. The valve mechanism (2) with the isolating plate (8) can be fitted after cool-down of the fitting to room temperature.

4.2.2 Installation of valve mechanism

1. Push the plug-in shaft head / hexagon (8) of the valve mechanism (2) fully down into the body.
2. Then firmly fit on the isolating plate (8) to the plug-in shaft head / hexagon (8). The isolating plate (8) is retained by means of an O-ring.
3. Fit the centering ring (14) with O-ring to ISO-KF of the pump-out port (5).
4. Screw the isolating plate (8) by a few turns into the pump-out port (5) by turning the knob on the shaft clockwise.
5. Only then fit the valve mechanism (2) vacuum-tight to the pump-out port (5), using the respective clamping ring (13), and screw in the isolating plate (8) until it fits tightly.



Before mounting the valve mechanism (2) to the pump-out port (5) by means of the centering ring (14) with O-ring and clamping ring (13), the hexagonal end of plug-in shaft head (8) must be firmly inserted into the isolating plate (8)

4.2.3 Connection Lines

1. The pumping or gas-filling line is connected vacuum-tight to the lateral ISO-KF flange of the valve mechanism (2) by means of centering ring (14) with O-ring and clamping ring (13).
2. Check that the vacuum connections are leak tight.

4.2.4 Admissible forces and bending moments

DN (nom. I. D.)		Axial tensile or compressive force « F_A »		Bending moment « M »	
mm	inch	N	lbf	Nm	lbf · ft
16	$\frac{5}{8}$	25	6	1	0.8
25	1	70	16	3	2.2
40	$1\frac{1}{2}$	100	22	6	4.5

A combination of both forces « F_A » and « M » is not allowed. Please contact VAT.

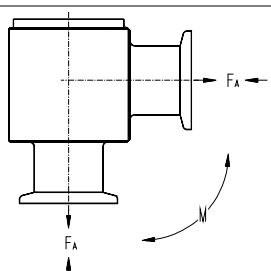

The diagram shows a cross-section of a valve mechanism. A horizontal dashed line represents the axis of symmetry. A force F_A is applied to the right side of the valve, pointing to the left. A bending moment M is applied to the bottom of the valve, pointing downwards.

Table 4-1

5 Operation

	<p style="text-align: center;">⚠ DANGER</p>
	<p>Overpressure in the vacuum system >1 bar Injury caused by released parts and harm caused by escaping process gases can result if clamps are opened while the vacuum system is pressurized. Do not open any clamps while the vacuum system is pressurized. Use the type of clamps which are suited to overpressure.</p>
	<p style="text-align: center;">⚠ DANGER</p>
	<p>Overpressure in the vacuum system >2.5 bar KF flange connections with elastomer seals (e.g. O-rings) cannot withstand such pressures. Process media can thus leak and possibly damage your health. Use O-rings provided with an outer centering ring.</p>
	<p style="text-align: center;">⚠ WARNING</p>
	<p>Unqualified personnel Inappropriate handling may cause serious injury or property damage. Only qualified personnel are allowed to carry out the described work.</p>
	<p style="text-align: center;">⚠ CAUTION</p>
	<p>Valve openings Human body parts may get jammed and severely injured. Do not operate before product is installed completely into the vacuum system.</p>
	<p style="text-align: center;">⚠ CAUTION</p>
	<p>Hot surfaces Risk of burning at valve with heater. Do not touch hot surfaces.</p>



The product is ready for operation as soon as it has been installed.

If the product is operated under harsh or dirty conditions, it should be cleaned / maintained before the specified service time has been reached.

5.1 Description

The shaft (8) acting as linear motion feedthrough, is sealed against atmosphere by two feedthrough seal (10) O-Rings. The shaft (8) is guided in a feedthrough seal (10).

The shaft (8) can be rotated and also moved in axial direction by means of the rotary knob. At the lower end of the shaft is plug-in head (8) that can be inserted into the hexagon socket of isolating plate (8). The isolating plate (8) is retained on the shaft head (9) by means of an O-ring and can be unscrewed from the pump-out port (5) and then pulled upward into the valve mechanism (2), where it is arrested.

5.2 Opening the pump-out port

After the valve mechanism (2) has been connected to the pump-out port (5), unscrew the isolating plate (8) from the pump-out port (5) by turning the knob anticlockwise.

Then slowly pull out the shaft (1) fully upwards. The gas flow is thus ensured.

When turning the shaft (1) in this upper stop position, the retaining pin on the shaft (4) can be passed through a slot in the retaining device (3) and locked in the open position turning the shaft (1) by 90°.

5.3 Closing the pump-out port

After the container or vessel has been evacuated or filled with gas, turn the shaft (1) clockwise (slightly pressing against the retaining device (3) until the retaining pin on shaft (4) passes through the slot and the shaft (1) can be moved toward the pump-out port (5).

Slowly push the shaft (1) with isolating plate (8) fitted on the Plug-in shaft head (9) into the pump-out port (5), sealing it vacuum-tight by turning the shaft (1) clockwise.

The valve mechanism (2) can be removed and used in the same way on other pump-out ports (5) of the same size.

5.4 Trouble shooting

Failure	Check	Action	See
Valve mechanism does not close / open	Pump-out port connected correctly?	Verify connection	Chapter «5.1 Description»
Leak at plate or body	Contamination?	Clean or replace seals	Chapter «6.3 Cleaning the valve mechanism»

Table 5-1

If you need any further information, please contact one of our service centers. You will find the addresses on our website www.vatvalve.com.

6 Maintenance

	DANGER
	<p>Overpressure in the vacuum system >1 bar</p> <p>Injury caused by released parts and harm caused by escaping process gases can result if clamps are opened while the vacuum system is pressurized.</p> <p>Do not open any clamps while the vacuum system is pressurized. Use the type of clamps which are suited to overpressure.</p>
	DANGER
	<p>Overpressure in the vacuum system >2.5 bar</p> <p>KF flange connections with elastomer seals (e.g. O-rings) cannot withstand such pressures. Process media can thus leak and possibly damage your health.</p> <p>Use O-rings provided with an outer centering ring.</p>
	WARNING
	<p>Unqualified personnel</p> <p>Inappropriate handling may cause serious injury or property damage.</p> <p>Only qualified personnel are allowed to carry out the described work.</p>
	CAUTION
	<p>Hazardous components</p> <p>Human body parts may get jammed and easily injured.</p> <p>Before starting maintenance:</p> <ul style="list-style-type: none"> – disconnect compressed air supply – disconnect electrical power supply
	CAUTION
	<p>Valve openings</p> <p>Human body parts may get jammed or easily injured.</p> <p>Keep human body parts away from valve openings.</p>
	CAUTION
	<p>Hot surfaces</p> <p>Risk of burning at valve with heater.</p> <p>Touch hot surfaces only if the valve has cooled down.</p>

NOTICE	
	<p>Contamination</p> <p>Product may get contaminated. Always wear cleanroom gloves when handling the product.</p>

NOTICE	
	<p>Inappropriate tools</p> <p>Sealing surfaces and valve plate may get damaged. Do not use sharp-edged tools.</p>

6.1 Maintenance intervals

Under clean operating conditions the valve does not require any maintenance
For more information or a general overhaul please contact one of our service centers. You will find the addresses on our website www.vatvalve.com.



Contamination resulting from the process may impair the function of the valve and require more frequent maintenance.

6.2 Required tools

- Allen wrench size 2.5, 3 (according to «Table 6-1»)
- Torque wrench (torques according to «Table 6-1»)
- Cleanroom wiper soaked with alcohol (2% methyl ethyl ketone)

	DN 16	DN 25	DN 40
Screw size	M3	M4	M4
Wrench size	2.5	3	3
Torque [Nm]	1	1.7	1.7

Table 6-1

6.3 Cleaning the valve mechanism

	<p style="text-align: center;">⚠ DANGER</p> <p>Overpressure in the vacuum system >1 bar Injury caused by released parts and harm caused by escaping process gases can result if clamps are opened while the vacuum system is pressurized. Do not open any clamps while the vacuum system is pressurized. Use the type of clamps which are suited to overpressure.</p>
	<p style="text-align: center;">⚠ DANGER</p> <p>Overpressure in the vacuum system >2.5 bar KF flange connections with elastomer seals (e.g. O-rings) cannot withstand such pressures. Process media can thus leak and possibly damage your health. Use O-rings provided with an outer centering ring.</p>
	<p style="text-align: center;">⚠ WARNING</p> <p>Unqualified personnel Inappropriate handling may cause serious injury or property damage. Only qualified personnel are allowed to carry out the described work.</p>
	<p style="text-align: center;">⚠ CAUTION</p> <p>Hazardous components Human body parts may get jammed and easily injured. Before starting maintenance: – disconnect compressed air supply – disconnect electrical power supply</p>
	<p style="text-align: center;">⚠ CAUTION</p> <p>Hot surfaces Risk of burning at valve with heater. Touch hot surfaces only if the valve has cooled down.</p>
	<p style="text-align: center;">NOTICE</p> <p>Contamination Product may get contaminated. Always wear cleanroom gloves when handling the product.</p>

NOTICE	
	<p>Inappropriate tools Sealing surfaces and valve plate may get damaged. Do not use sharp-edged tools.</p>

1. Undo the fastening screws (12) on the valve mechanism (2).
2. Lift off the cover with shaft (1) and turning knob.
3. Clean the parts.
4. Reassemble in reverse order.

Valve mechanism (2) is ready for use.

6.4 Cleaning the pump-out port

⚠ DANGER	
	<p>Overpressure in the vacuum system >1 bar Injury caused by released parts and harm caused by escaping process gases can result if clamps are opened while the vacuum system is pressurized. Do not open any clamps while the vacuum system is pressurized. Use the type of clamps which are suited to overpressure.</p>

⚠ DANGER	
	<p>Overpressure in the vacuum system >2.5 bar KF flange connections with elastomer seals (e.g. O-rings) cannot withstand such pressures. Process media can thus leak and possibly damage your health. Use O-rings provided with an outer centering ring.</p>

⚠ WARNING	
	<p>Unqualified personnel Inappropriate handling may cause serious injury or property damage. Only qualified personnel are allowed to carry out the described work.</p>

	⚠ CAUTION
	<p>Hazardous components</p> <p>Human body parts may get jammed and easily injured.</p> <p>Before starting maintenance:</p> <ul style="list-style-type: none"> – disconnect compressed air supply – disconnect electrical power supply

	⚠ CAUTION
	<p>Hot surfaces</p> <p>Risk of burning at valve with heater.</p> <p>Touch hot surfaces only if the valve has cooled down.</p>

	NOTICE
	<p>Contamination</p> <p>Product may get contaminated.</p> <p>Always wear cleanroom gloves when handling the product.</p>

	NOTICE
	<p>Inappropriate tools</p> <p>Sealing surfaces and valve plate may get damaged.</p> <p>Do not use sharp-edged tools.</p>

1. Unscrew the isolating plate (8) from the pump-out port (5)
2. Place the isolating plate (8) at a clean and safe place.
3. Clean the parts.
4. Reassemble in reverse order.

Pump-out port (5) is ready for use.



7 Repairs

Repairs may only be carried out by the VAT service staff. In exceptional cases, the customer is allowed to carry out the repairs, but only with the prior consent of VAT.

Please contact one of our service centers. You will find the addresses on our website www.vatvalve.com.

8 Dismounting and Storage

	⚠ WARNING
	<p>Unqualified personnel Inappropriate handling may cause serious injury or property damage. Only qualified personnel are allowed to carry out the described work.</p>

8.1 Dismounting

	⚠ DANGER
	<p>Overpressure in the vacuum system >1 bar Injury caused by released parts and harm caused by escaping process gases can result if clamps are opened while the vacuum system is pressurized. Do not open any clamps while the vacuum system is pressurized. Use the type of clamps which are suited to overpressure.</p>

	⚠ DANGER
	<p>Overpressure in the vacuum system >2.5 bar KF flange connections with elastomer seals (e.g. O-rings) cannot withstand such pressures. Process media can thus leak and possibly damage your health. Use O-rings provided with an outer centering ring.</p>

	⚠ CAUTION
	<p>Hazardous components Human body parts may get jammed and easily injured. Before dismantling the product:</p> <ul style="list-style-type: none"> – disconnect compressed air supply – disconnect electrical power supply

	⚠ CAUTION
	<p>Hot surfaces Risk of burning at valve with heater. Touch hot surfaces only if the valve has cooled down.</p>

	NOTICE
	<p>Contamination Product may get contaminated. Always wear cleanroom gloves when handling the product.</p>

1. Disconnect connection lines.
2. Dismount valve mechanism (2) from system.

8.2 Storage

NOTICE	
	<p>Wrong storage</p> <p>Inappropriate temperatures and humidity may cause damage to the product.</p> <p>Valve must be stored at:</p> <ul style="list-style-type: none">– relative humidity between 10% and 70%– temperature between +10 °C and +50 °C– non-condensing environment

NOTICE	
	<p>Inappropriate packaging</p> <p>Product may get damaged if inappropriate packaging material is used.</p> <p>Always use the original packaging material and handle product with care.</p>

1. Clean / decontaminate valve.
3. Cover all valve openings with a protective foil.
4. Pack valve appropriately, by using the original packaging material.

9 Packaging and Transport

	WARNING
	Unqualified personnel Inappropriate handling may cause serious injury or property damage. Only qualified personnel are allowed to carry out the described work.

	WARNING
	Harmful substances Risk of injury in case of contact with harmful substances. Remove harmful substances (e. g. toxic, caustic or microbiological ones) from valve before you return the valve to VAT.

	NOTICE
	Inappropriate packaging Product may get damaged if inappropriate packaging material is used. Always use the original packaging material and handle product with care.



- When returning products to VAT, please fill out the VAT form «Declaration of Chemical Contamination» and send it to VAT in advance. The form can be downloaded from our website www.vatvalve.com.
- If products are radioactively contaminated, the VAT form «Contamination and Radiation Report» must be filled out. Please contact VAT in advance.
- If products are sent to VAT in contaminated condition, VAT will carry out the decontamination procedure at the customer's expense.

9.1 Packaging

NOTICE	
	<p>Valve in open position Valve mechanism may get damaged if valve is in open position. Make sure that the valve is closed.</p>

1. Cover all valve openings with a protective foil.
5. Pack valve appropriately, by using the original packaging material.



VAT disclaims any liability for damages resulting from inappropriate packaging.

9.2 Transport

NOTICE	
	<p>Inappropriate packaging Product may get damaged if inappropriate packaging material is used. Always use the original packaging material and handle product with care.</p>



VAT disclaims any liability for damages resulting from inappropriate packaging.

10 Disposal

Observe the local regulations for disposal

	⚠ WARNING
	Harmful substances Environmental pollution. Discard products and parts according to the local regulations.



- Hire an authorised waste disposal company to dispose of the waste in a professional manner.

11 Spare parts



NOTICE

Non-original spare parts

Non-original spare parts may cause damage to the product.
Use original spare parts from VAT only.



- Please specify the fabrication number of the product when you place an order for spare parts; see chapter «1.1 Identification of product». This is to ensure that the appropriate spare parts are supplied.
- VAT makes a difference between spare parts that may be replaced by the customer and those that need to be replaced by the VAT service staff.
- If you need spare parts, please contact one of our service centers. You will find the addresses on our website www.vatvalve.com.

12 Appendix

Aim and purpose

Each entrepreneur (operating company) is responsible for the health and safety of its employees. The responsibility extends to external personnel carrying out repairs on the site of the operating company and to personnel of contractors.



The same regulations apply for **on-site repairs**.

Preparation for dispatch

Before dispatching the product the operating company must fill out the declaration of chemical contamination and enclose it to the shipping documents. The shipping instructions stated in the relevant user manual must be observed.

For example:

- Drain all service fluids
- Remove filter elements, where applicable
- Close all openings airtight
- Pack products appropriately
- Dispatch products in suitable transport containers



Attach declaration on contamination to the **outside** of the transport container.

