

Installation, Operating & Maintenance Instructions



Large transfer valve TwinVAT with double acting pneumatic actuator

Series 061

**100 × 1000 mm (3.94" × 39.37") to
300 × 3800 mm (11.81" × 149.61")**

This manual is valid for the following product ordering numbers:

For all 0610X- with a double opening (double TwinVAT)

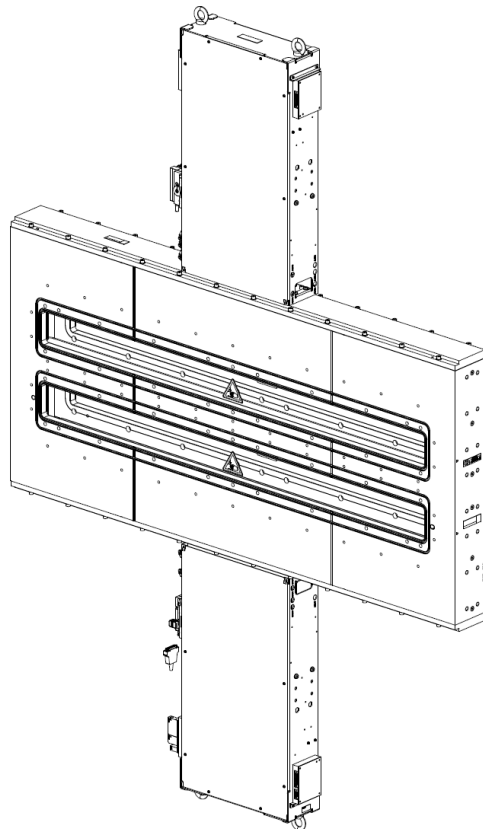

Imprint

Manufacturer VAT Vakuumventile AG, CH-9469 Haag, Switzerland

Website: www.vatvalve.com
Phone: +41 81 771 61 61
Fax: +41 81 771 48 30
Email: CH@vatvalve.com

Publisher VAT Vakuumventile AG, CH-9469 Haag, Switzerland

Editor VAT Vakuumventile AG, CH-9469 Haag, Switzerland

Print VAT Vakuumventile AG, CH-9469 Haag, Switzerland

Copyright © VAT Vakuumventile AG 2019

No part of these instructions may be reproduced in any way (photocopies, microfilms or any other reproduction processes) nor may it be manipulated with electronic systems, duplicated or distributed without written permission from VAT. Offenders are liable to pay damages.

The original VAT firmware and updated state of the art versions of the VAT firmware are intended for use with VAT products. The VAT firmware contains a limited, time unlimited user license. The VAT firmware may not be used for purposes other than those intended nor is it permitted to make copies of the VAT firmware. In particular, it is strictly forbidden to give copies of the VAT firmware to other people.

The use of trade names, brand names, trademarks, etc. in these Instructions does not entitle third parties to consider these names to be unprotected and to use them freely. This is in accordance with the meaning of the laws and acts covering brand names and trademarks.

Contents

1	Description of product.....	5
1.1	Identification of product.....	5
1.2	Use of product.....	5
1.3	Related documents.....	5
1.4	Important information.....	6
1.5	Technical data.....	6
1.6	Common labeling for interfaces and position indicators.....	6
2	Safety	7
2.1	Compulsory reading material.....	7
2.2	Danger levels	7
2.3	Personnel qualifications.....	8
2.4	Safety labels.....	8
3	Design and Function.....	9
3.1	Design.....	9
3.2	Function	10
4	Installation	11
4.1	Unpacking	11
4.2	Installation into the system.....	13
4.3	Electrical connection.....	16
4.3.1	Electrical connection with control unit.....	16
4.4	Compressed air connection	17
4.4.1	Compressed air connection with solenoid valve or control unit	17
4.5	Initial operation.....	18
5	Operation	21
5.1	Normal operation.....	21
5.2	Operation under increased temperature.....	21
5.3	Behavior in case of compressed air pressure drop.....	21
5.4	Behavior in case of power failure	21
5.5	Trouble shooting.....	22
5.5.1	Control unit trouble shooting	23
6	Maintenance	24
6.1	Maintenance intervals.....	24
6.2	Required tools	25
6.3	Service operations.....	26
6.3.1	Service position 1	26
6.3.2	Service position 2	26
6.3.3	Service position 3 – not applicable for this product configuration!	27
6.4	Replacement of gate O-ring via actuator flange (actuator down)	28
6.5	Replacement of gate O-ring via actuator flange (actuator up).....	31
6.6	Replacement of gate via actuator flange (actuator down)	33
6.7	Replacement of gate via actuator flange (actuator up)	35
7	Repairs	38
8	Dismounting and Storage.....	39

8.1	Dismounting	40
8.2	Storage	40
9	Packaging and Transport.....	41
9.1	Packaging	42
9.2	Transport	42
10	Disposal.....	43
11	Spare parts.....	44

1 Description of product

1.1 Identification of product

The fabrication number and order number are fixed on the product directly or by means of an identification plate.

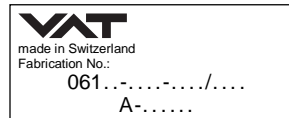

← Fabrication number

← Order number

1.2 Use of product

Use product for clean and dry vacuum applications only. Other applications are only allowed with the written permission of VAT.

1.3 Related documents

- Product data sheets
- IOMI of valve options
- Dimensional drawing
- Design specification customer chamber
- Spare parts list
- Pneumatic diagram and control sequences

1.4 Important information



This symbol points to a very important statement that requires particular attention.

Example:



VAT disclaims any liability for damages resulting from inappropriate packaging.

1.5 Technical data

NOTICE	
	<p>Technical specification on parts from third-party suppliers</p> <p>Product may get damaged.</p> <p>Regardless of specification on parts from third-party suppliers, the product only must be operated according the technical details in the VAT product data sheet.</p>

See product data sheet, dimensional drawing and design specification customer chamber.

1.6 Common labeling for interfaces and position indicators

Air connection:

ACMP: Air Connection Main Pressure
ACVO: Air Connection Vertical Open
ACVC: Air Connection Vertical Close
ACHO: Air Connection Horizontal Open
ACHC: Air Connection Horizontal Close
ACHR: Air Connection Horizontal Release

Solenoid Valves:

SVVO: Solenoid Valve Vertical Open
SVVC: Solenoid Valve Vertical Close
SVHO: Solenoid Valve Horizontal Open
SVHC: Solenoid Valve Horizontal Close
SVHR: Solenoid Valve Horizontal Release

Check Valve:

CVHR: Check Valve Horizontal Release

Position Indicators:

PIVO: Position Indicator Vertical Open
PIVC: Position Indicator Vertical Close
PIHO: Position Indicator Horizontal Open
PIHC: Position Indicator Horizontal Close

For further details please refer to product data sheet with pneumatic diagram and control sequences.

2 Safety

2.1 Compulsory reading material

Read this chapter prior to performing any work with or on the product. It contains important information that is significant for your own personal safety. This chapter must have been read and understood by all persons who perform any kind of work with or on the product during any stage of its serviceable life.

	NOTICE
	<p>Lack of knowledge Failing to read this manual may result in property damage. Firstly, read manual.</p>





These Installation, Operating & Maintenance Instructions are an integral part of a comprehensive documentation belonging to a complete technical system. They must be stored together with the other documentation and accessible for anybody who is authorized to work with the system at any time.

2.2 Danger levels

	⚠ DANGER
	<p>High risk Indicates a hazardous situation which, if not avoided, will result in death or serious injury.</p>

	⚠ WARNING
	<p>Medium risk Indicates a hazardous situation which, if not avoided, could result in death or serious injury.</p>

	⚠ CAUTION
	<p>Low risk Indicates a hazardous situation which, if not avoided, may result in minor or moderate injury.</p>

	NOTICE
	<p>Command Indicates a hazardous situation which, if not avoided, may result in property damage.</p>

2.3 Personnel qualifications

	WARNING
	<p>Unqualified personnel Inappropriate handling may cause serious injury or property damage. Only qualified personnel are allowed to carry out the described work.</p>

2.4 Safety labels

Label	Part No.	Location on valve
	T-9001-156	On the protective foils covering the valve openings
<p style="text-align: center; font-weight: bold; color: blue;">NOTICE</p> <p>Mechanical overloading Valve body can be damaged</p> <p><small>Operate valve only when structural support on both sides of the valve body is provided either by chamber flanges or by test flanges designed or approved by VAT.</small></p>	485160	Top, bottom & sides of valve body
<p style="text-align: center; font-weight: bold; color: red;">DANGER</p> <p>HAZARD WEIGHT DANGER OF LIFE</p> <p><small>Do NOT use this lifting point to raise the whole unit. Read Installation, Operation and Maintenance instruction before lifting.</small></p>	405300	On valve actuator.

Table 2-1

3 Design and Function

3.1 Design

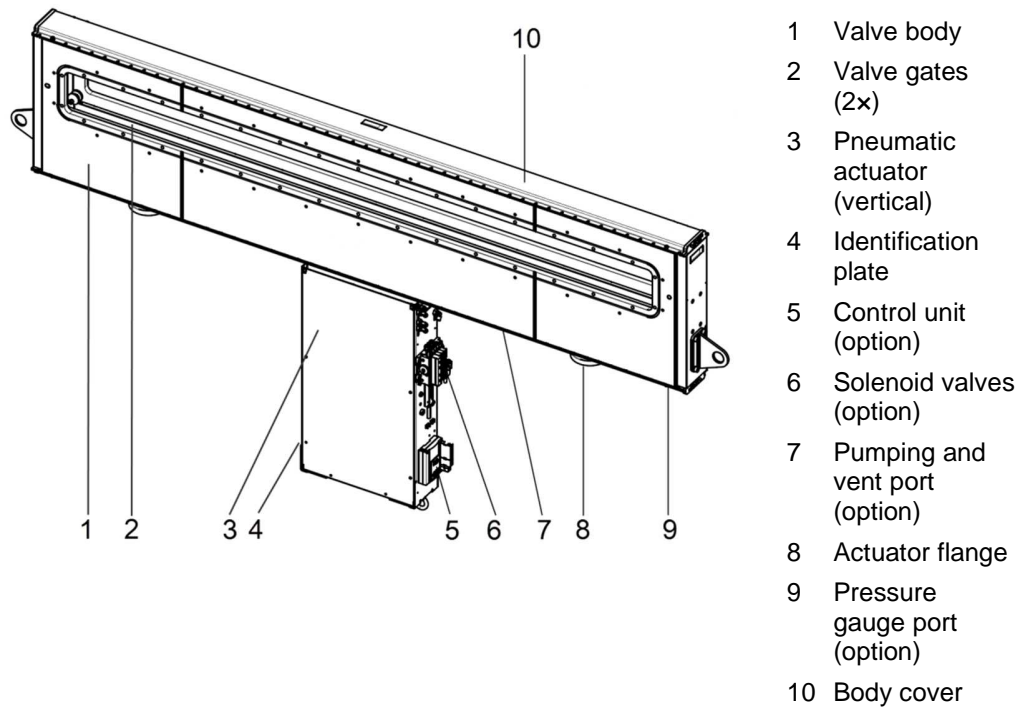

Figure 3-1

3.2 Function

The vertical pneumatic actuator moves the gates to the open or retracted closed position. The horizontal actuator moves the gates from the retracted open position to the extended closed and pneumatically locked position. Leak tightness of the closed valve gates is ensured by a homogeneous O-ring compression through the horizontal actuator and through a differential pressure on the gate in close direction.

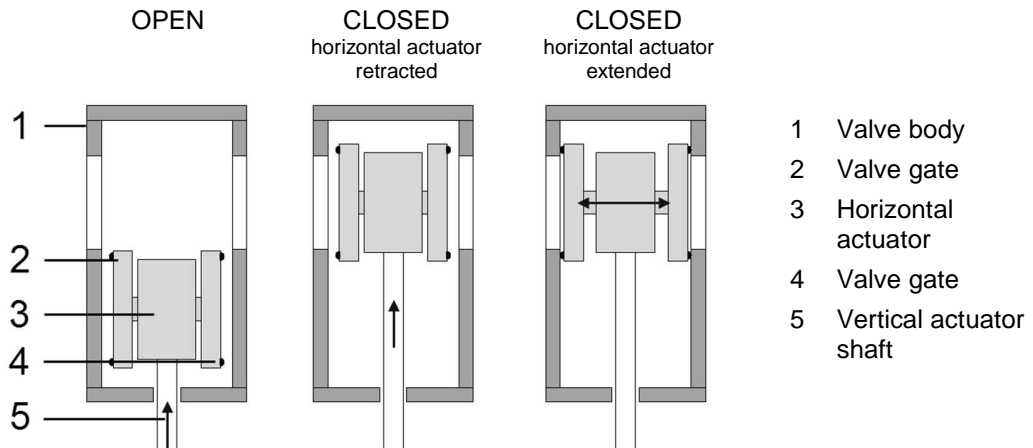





Figure 3-2

4 Installation

	 WARNING
	<p>Unqualified personnel Inappropriate handling may cause serious injury or property damage. Only qualified personnel are allowed to carry out the described work.</p>

	 WARNING
	<p>Heavy weight Physical overstraining. Use a crane to lift the product.</p>

4.1 Unpacking



- Make sure that the supplied products are in accordance with your order.
- Inspect the quality of the supplied products visually. If it does not meet your requirements, please contact VAT immediately.
- Store the original packaging material. It may be useful if products must be transported or returned to VAT.

	NOTICE
	<p>Suspended load The actuators will be damaged if they touch the ropes or any solid object. Use assisting staff when handling the valve by a crane.</p>

1. Remove cover from transport box.
2. Remove inside packing material as far as necessary.



- Do not remove protective foils from valve opening.
- Depending on the weight of the product, use suitable lifting ropes. Weight, see product data sheet.
- Mounting position is specified in the dimensional drawing.

3. Fasten the lifting ropes at the two lifting points (1); see «Figure 4-1».



The ropes must be in an angle of 90° while lifting the valve. Another angle could cause deformation to the valve.

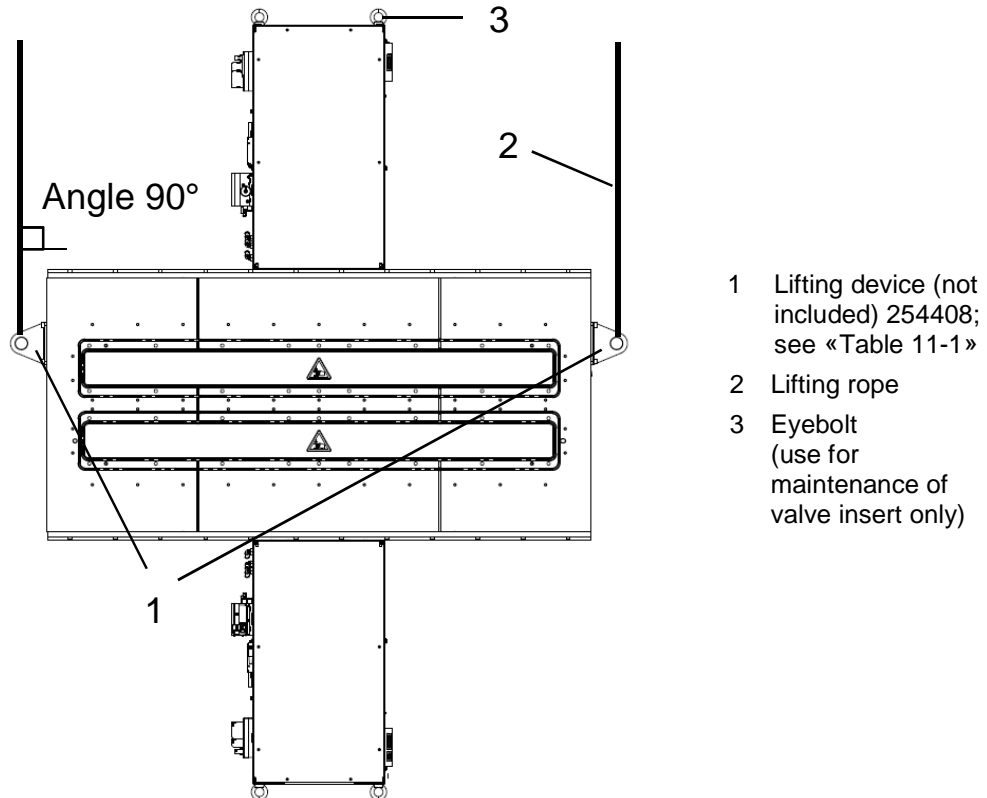

- 1 Lifting device (not included) 254408; see «Table 11-1»
- 2 Lifting rope
- 3 Eyebolt (use for maintenance of valve insert only)

Figure 4-1

4. Lift valve out of transport box by using a crane and assisting staff.

NOTICE	
	<p>Sensitive product Product will get damaged if not handled carefully. Do not put the valve on the ground with actuators down.</p>





Store transport box and package material. It may be useful for later transport of the valve. Protective foils should only be removed immediately before mounting the valve to the system.

4.2 Installation into the system

	⚠ WARNING
	<p>Hazardous components</p> <p>Parts, loaded springs, air cushions etc. may move or release a movement and cause serious injury.</p> <p>Do not connect or supply electrical power and compressed air before the product is completely mounted in the system.</p>

	NOTICE
	<p>Operation of the valve</p> <p>Product will get damaged.</p> <p>Never actuate the valve before it is installed! For proper operation, the valve needs stability that is only ensured when it is impeccably mounted between two chambers or between two test flanges which are supplied or approved by VAT. Disregarding this instruction will cause damage to the valve body.</p>

	NOTICE
	<p>Contamination</p> <p>Product may get contaminated.</p> <p>Always wear cleanroom gloves when handling the product.</p>

	NOTICE
	<p>Insufficient stability</p> <p>Product may get damaged when actuated at this stage.</p> <p>Do not operate before product is installed completely into the vacuum system.</p>



- Make sure that sealing surfaces of valve and chamber are undamaged. Mount valve to a clean system only.
- Make sure that dimensions and tolerances specified in the dimensional drawing strictly met.
- Make sure that the valve is in a stable position and cannot fall over if it is placed on a surface.

1. Lay the valve in horizontal position on a clean and even surface (e.g. back to transportation box).

2. Remove protective foil from the valve.
3. Remove screw (1) with an allen wrench size 6 from transportation safety devices (2) of the **upper opening**; see «Figure 4-2».
4. Remove 4 x red plastic transportation safety devices that hold the gate on its place from the **upper opening** (2); see «Figure 4-2».

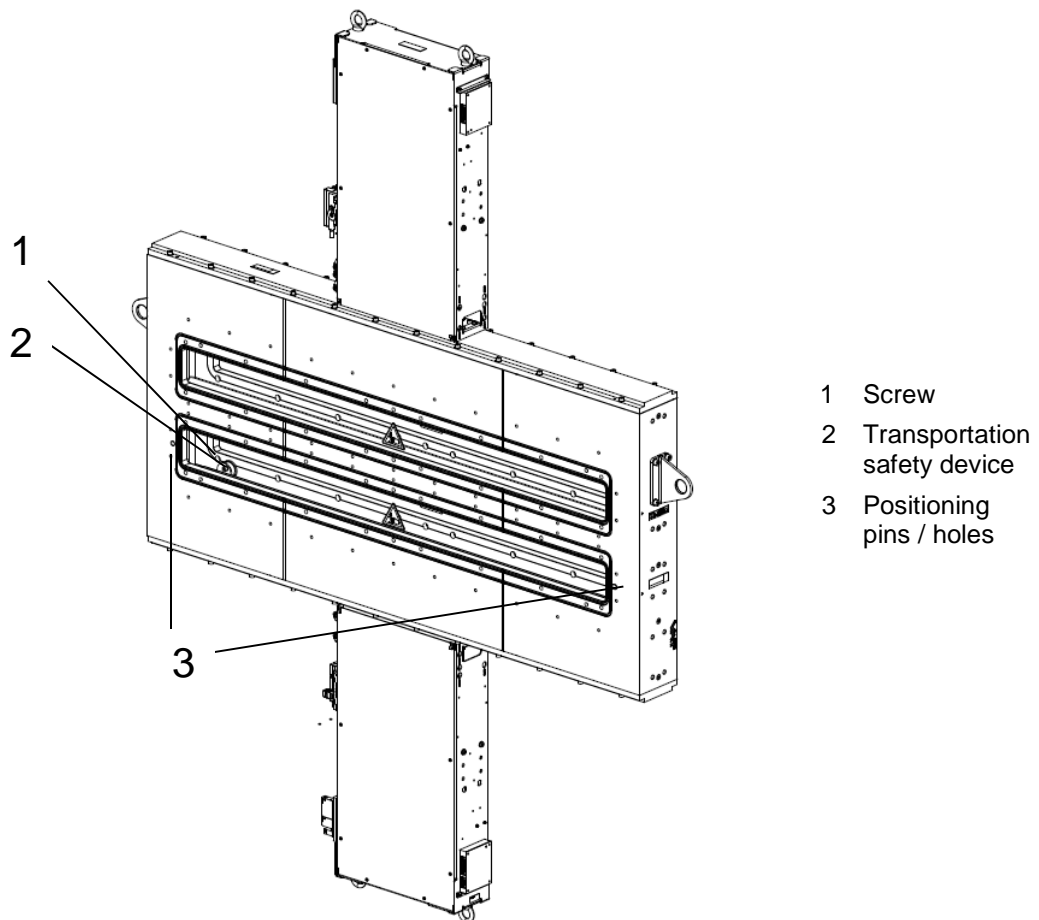

Figure 4-2

5. Lift the valve **slowly** to upright position, while carefully securing the smooth landing of the unsecured upper gates to the optical closed position. For this you need additional personnel.



- The insert of the upper opening with both gates should slowly move downwards to avoid any large shock to the valve.

**NOTICE****Sensitive product**

Pay extra care for securing the smooth lowering of the gated of the upper opening while lifting the valve to upright position.

6. When the valve is in upright position, remove 4x red plastic transportation safety devices that hold the gate on its place from the **lower opening** (2); see «Figure 4-2
7. Clean sealing surface and / or O-ring of chamber.
8. Make sure that the positioning pins are in place on valve body or chamber.
9. Align mounting holes of valve and chamber and fasten it together with screws.

**NOTICE****Wrong tightening torque**

Valve body and screws may get damaged.

Use tightening torque according the size of the screws.

10. Perform steps 7 to 9 with the other side of the valve.

4.3 Electrical connection

	NOTICE
	<p>Wrong voltage Electrical components may get damaged. Supply electrical components with the correct voltage.</p>

4.3.1 Electrical connection with control unit





Verify valve type on the identification plate;
see chapter «1.1 Identification of product».

Ordering number: 061...-..49 with solenoid valves and with control unit

1. Connect control unit according to the product data sheets.

4.4 Compressed air connection

 WARNING	
	<p>Valve in open position</p> <p>Risk of injury when compressed air is connected to the valve.</p> <p>Connect compressed air only when:</p> <ul style="list-style-type: none">- valve is installed in the vacuum system- moving parts cannot be touched



Use clean, dry or slightly oiled air only.



Admissible air pressure range, see product data sheet.

4.4.1 Compressed air connection with solenoid valve or control unit





Verify valve type on the identification plate;
see chapter «1.1 Identification of product»

Ordering number: 061...49 with solenoid valves and with control unit

1. Connect compressed air according to the product data sheets and dimensional drawing.

4.5 Initial operation

 WARNING	
	<p>Movable parts</p> <p>Human body parts may get jammed and severely injured. Keep human body parts away from movable parts.</p>

NOTICE	
	<p>Operation of the valve</p> <p>Product will get damaged.</p> <p>Never actuate the valve before it is installed! For proper operation, the valve needs stability that is only ensured when it is impeccably mounted between two chambers or between two test flanges which are supplied or approved by VAT. Disregarding this instruction will cause damage to the valve body.</p>



In order to ensure leak tightness of the valve, it's essential to carry out one cycle (open and close movement).

Open movement

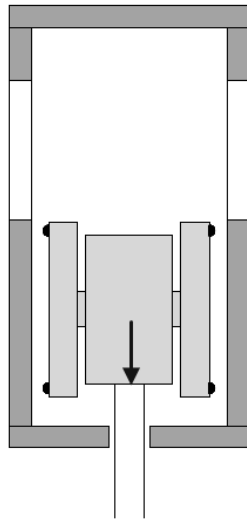

Operate the vertical shaft into the retracted position while both gates are retracted.

Movement	Command/Verify	Comment
Horizontal open	<ul style="list-style-type: none"> •open horizontal cylinders 	Check valve Horizontal release (CVHR). Command horizontal cylinders into open position (ACHO) and release air from the horizontal close cylinders (ACHC).
Horizontal open	<ul style="list-style-type: none"> •verify valve position 	Verify position indicators that horizontal cylinders are in open position (PIHO).
Vertical open	<ul style="list-style-type: none"> •open vertical cylinders 	Command vertical cylinders into open position (ACVO) and release air from the vertical close cylinders (ACVC).
Vertical open	<ul style="list-style-type: none"> •verify valve position 	Verify position indicators that valve is in open position (PIVO).

For more details refer to the pneumatic diagram and control sequences.

Close movement

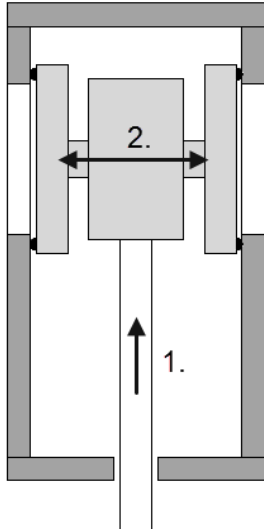



Operate the gates into the extended position while the vertical shaft is fully extended.

Movement	Command/Verify	Comment
Vertical close	<ul style="list-style-type: none"> •Verify valve position 	Verify that horizontal cylinders are open and that both gates are retracted (PIHO).
Vertical close	<ul style="list-style-type: none"> •close vertical cylinder 	Command vertical cylinders into close position (ACVC) and release air from the vertical open cylinders (ACVO).
Vertical close	<ul style="list-style-type: none"> •verify valve position 	Verify position indicators that vertical cylinders are in closed position (PIVC).
Horizontal close	<ul style="list-style-type: none"> • close horizontal cylinders 	Command horizontal cylinders into close position (ACHC) and release air from the horizontal open cylinders (ACHO).
Horizontal close	<ul style="list-style-type: none"> •verify valve position 	Verify position indicators that the valve is in closed position (PIHC).

For more details refer to the pneumatic diagram and control sequences.

5 Operation

	⚠ WARNING
	Unqualified personnel Inappropriate handling may cause serious injury or property damage. Only qualified personnel are allowed to carry out the described work.

	⚠ WARNING
	Movable parts Human body parts may get jammed and severely injured. Do not operate before product is installed completely into the vacuum system.

	NOTICE
	Technical specification on parts from third-party suppliers Product may get damaged. Regardless of specification on parts from third-party suppliers, the product only must be operated according the technical details in the VAT product data sheet.

	NOTICE
	Operation of the valve Product will get damaged. Never actuate the valve before it is installed! For proper operation, the valve needs stability that is only ensured when it is impeccably mounted between two chambers or between two test flanges which are supplied or approved by VAT. Disregarding this instruction will cause damage to the valve body.

5.1 Normal operation

The valve is opened and closed pneumatically.

5.2 Operation under increased temperature

Maximum allowed temperature, see product data sheet.

5.3 Behavior in case of compressed air pressure drop

See product data sheet.

5.4 Behavior in case of power failure

See product data sheet.

5.5 Trouble shooting

Failure	Check	Action	See
Valve cannot be actuated	Transportation safety devices still in place?	Remove transportation safety devices	«4.2 Installation into the system»
	Service mode activated?	Reset service mode	«4.3 Electrical connection»
	Voltage available?	Check voltage	«4.3 Electrical connection»
	Compressed air connected?	Check compressed air	«4.4 Compressed air connection»
Leak at valve gate	Contamination?	Clean valve seat and valve gate	«6.4 Replacement of gate O-ring via actuator flange (actuator down)» «6.5 Replacement of gate O-ring via actuator flange (actuator up)»
	Gate O-ring damaged?	Replace gate O-ring	«6.4 Replacement of gate O-ring via actuator flange (actuator down)» «6.5 Replacement of gate O-ring via actuator flange (actuator up)»
	Gate damaged?	Replace gate	«6.6 Replacement of gate via actuator flange (actuator down)» «6.7 Replacement of gate via actuator flange (actuator up)»
	Gate O-ring sufficiently compressed?	Check compressed air pressure	«4.4 Compressed air connection»
Leak at valve body	Contamination or unfastened actuator flange connection or body cover connection?	Check fittings and sealings at actuator flange and body cover	–
	Contamination or unfastened flange connection?	Check flange seals	–
	Contamination or unfastened pumping flange connection	Check pumping flange seals	–
Leak at valve body	Leak at bellows or shaft feedthrough?	Contact VAT	www.vatvalve.com

Table 5-1

5.5.1 Control unit trouble shooting

The status of the valve controller is communicated by signals as stated below. In case of malfunctioning of the valve the control unit signals indicate a specific status which can be used to trouble shoot the valve. The table below displays the possible signal combinations.

Nr.	Valve open	Valve close	Gate service	Bit 1	Bit 2	Bit 3	Service mode*)	Service mode deactivated
1	x			x				x
2		x			x			x
3			x	x	x		x	
4			x			x	x	
5			x	x		x	x	
6								x
7					x	x		x
8				x	x	x		x





*) Service mode: Is activated during any service position to prevent valve movements

The number from above table corresponds with the number of the explanation table below.

Nr.	Status	Action
1	valve in OPEN position	ready for operation
2	valve in CLOSE position	ready for operation
3	valve in SERVICE position 1, service mode activated	ready for service; after service, deactivate service mode for operation
4	valve in SERVICE position 2, service mode activated	ready for service; after service, deactivate service mode for operation
5	valve in SERVICE position 3, service mode activated	ready for service; after service, deactivate service mode for operation
6	SERVICE mode deactivated, valve in UNDEFINED position	check the valve position; ready for operation
7	Interaction of signal, valve in UNDEFINED position	check the electrical power supply; check the cable connections
8	position indicator failure, valve in UNDEFINED position	deactivate service mode; in case of continuing error, check the signal inputs

If you need any further information, please contact one of our service centers. You will find the addresses on our website www.vatvalve.com.

6 Maintenance

	<p style="text-align: center;">⚠ WARNING</p> <p>Unqualified personnel Inappropriate handling may cause serious injury or property damage. Only qualified personnel are allowed to carry out the described work.</p>
	<p style="text-align: center;">⚠ WARNING</p> <p>Heavy weight Physical overstraining. Use a crane to lift the valve insert.</p>
	<p style="text-align: center;">⚠ WARNING</p> <p>Hazardous components Parts, loaded springs, air cushions etc. may move or release a movement and cause serious injury. Before starting maintenance: – disconnect compressed air supply – disconnect electrical power supply</p>
	<p style="text-align: center;">⚠ WARNING</p> <p>Movable parts Human body parts may get jammed and severely injured. Keep human body parts away from movable parts.</p>

6.1 Maintenance intervals

If the valve is operated under clean conditions, VAT recommends replacing the gate O-ring as specified in the product data sheet; see chapter «6.4 Replacement of gate O-ring via actuator flange (actuator down)» or «6.5 Replacement of gate O-ring via actuator flange (actuator up)».

Under normal operating conditions the gate does not require any maintenance. However, in case of severe contamination, it may be dismantled for cleaning or replaced; see chapter «6.6 Replacement of gate via actuator flange (actuator down)» or «6.7 Replacement of gate via actuator flange (actuator up)».



- Influences from the process may require more frequent maintenance.
- If the valve has reached the specified life cycle – see product data sheet – we recommend a general overhaul by VAT. Please contact one of our service centers. You will find the contact data on our website www.vatvalve.com.

6.2 Required tools

- Allen wrench size 5 (M6)
- Torque wrench 9 Nm
- Slotted screwdriver size 1
- Cleanroom wiper soaked with alcohol (2% methyl ethyl ketone)
- O-ring removal tool; see «Figure 6-1» and «Table 11-1»
- Convenience tool 239582 or 424623; see «Table 11-1»
- Guide 734585; see «Table 11-1»

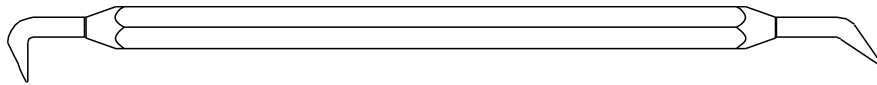
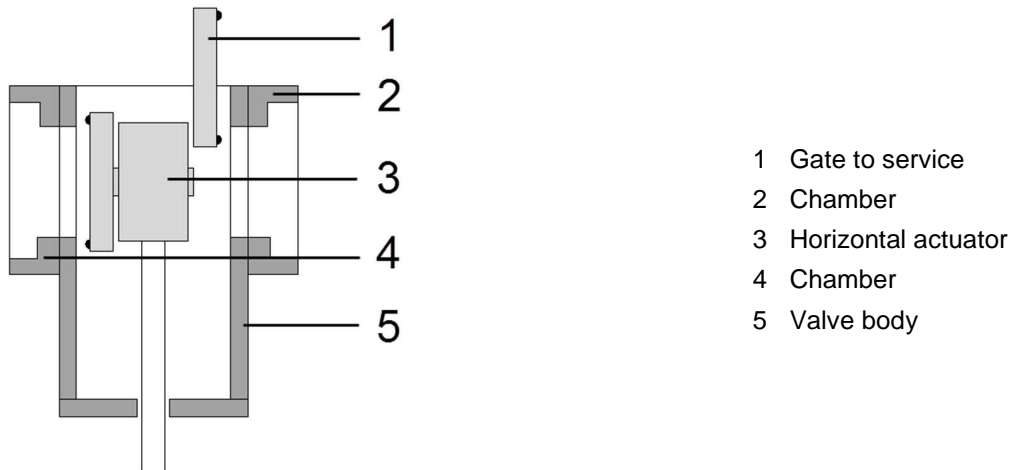

Figure 6-1

6.3 Service operations

6.3.1 Service position 1

In service position 1 the vertical cylinders are in close position and the horizontal cylinders are in open position. For the double TwinVAT product configuration, Service Position 1 is used for replacing the gate of the upper valve insert.



For more details how to command the valve in service position 1, please see the product data sheet with pneumatic diagram and control sequences

6.3.2 Service position 2

In service position 2 the vertical cylinders and the horizontal cylinders are in open position. The gate and the horizontal actuators can be removed through the actuator flange. For the double TwinVAT product configuration, Service Position 2 is used for replacing the gate of the lower valve insert.

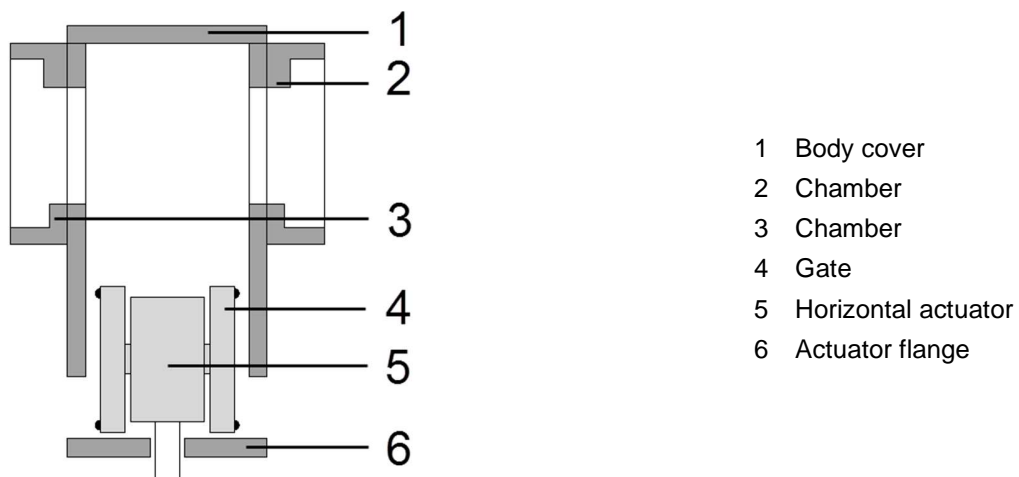





For more details how to command the valve in service position 2, please see the product data sheet with pneumatic diagram and control sequences

6.3.3**Service position 3 – not applicable for this product configuration!****NOTICE**

Service position 3 is not applicable for this product configuration!

6.4 Replacement of gate O-ring via actuator flange (actuator down)

	<p style="text-align: center;">WARNING</p> <p>Heavy weight Physical overstraining. Use a crane to lift the product.</p>
	<p style="text-align: center;">NOTICE</p> <p>Suspended load Product may get damaged when colliding with solid objects. Assistant staff should help each other when carrying out the work.</p>
	<p style="text-align: center;">NOTICE</p> <p>Contamination Product may get contaminated. Always wear cleanroom gloves when handling the product.</p>
	<p style="text-align: center;">NOTICE</p> <p>Inappropriate tools Sealing surfaces may get damaged. Do not use sharp-edged tools.</p>

1. Set valve to service position 2.
2. Vent both chambers and valve body.
3. Disconnect compressed air supply.
4. Disconnect electrical power supply.



- Mount supporting device (A) (not supplied by VAT) for dismantling the valve insert only at the designated points; see «Figure 6-2» on page 29.
- Weight of valve insert, see product data sheet.

5. Remove screws (3) with an allen wrench size 5 from actuator flange (1); see «Figure 6-2» on page 29.

6. Lower valve insert (4) with supporting device; see «Figure 6-2».

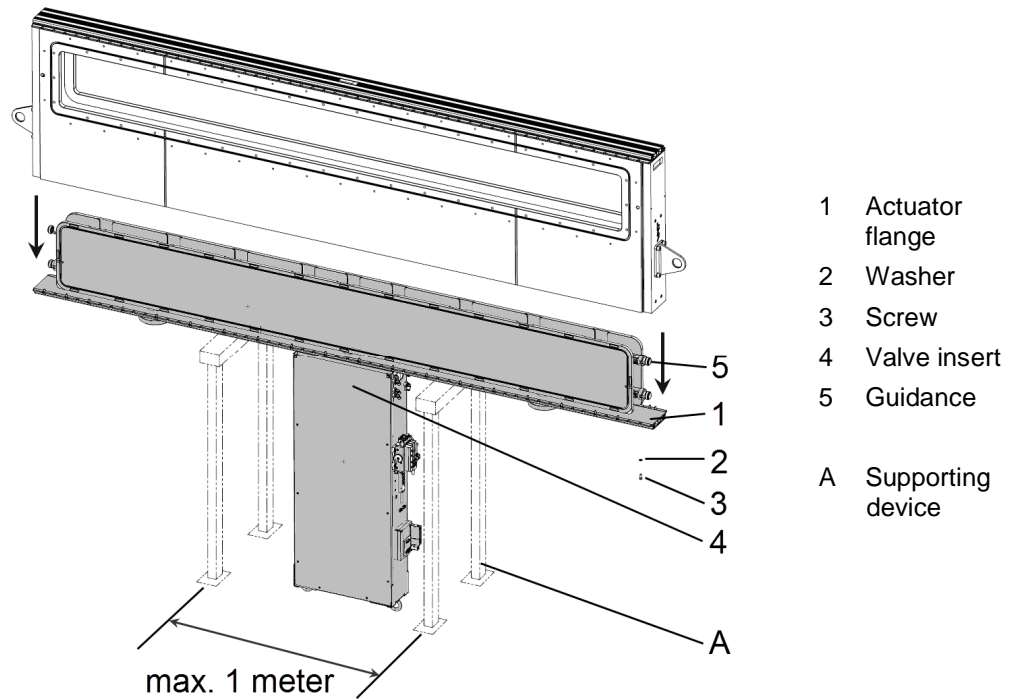

Figure 6-2

7. Place valve insert on an even and clean surface.
8. Clean 4x guidance (5) if required
9. Remove O-ring (7) with O-ring removal tool; see «Figure 6-1» on page 25. Begin at the indicated access point (X); see «Figure 6-3».

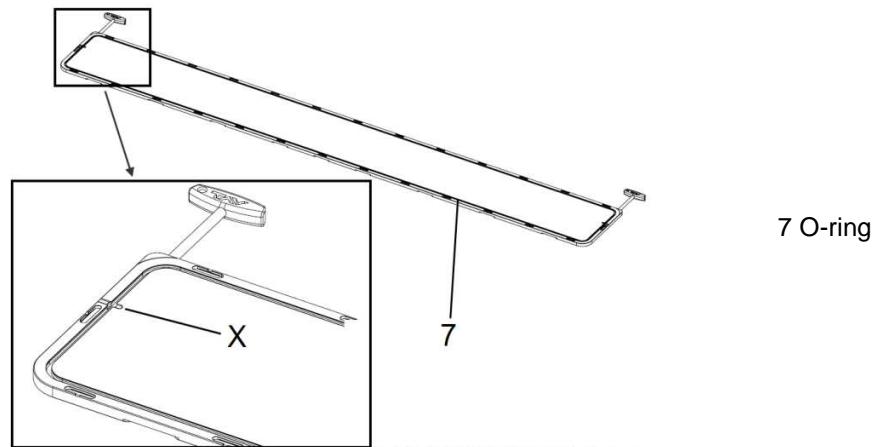

Figure 6-3

10. Clean sealing surfaces, use cleanroom wiper.
11. Insert new O-ring.
12. Repeat the steps 9-11 for the second gate if needed.
13. Clean sealing surface of actuator flange and O-ring of valve body, use cleanroom wiper.
14. Reassemble the valve.







VAT recommends replacing the screws on the actuator flange and / or body cover; see chapter «11 Spare parts».

15. Tighten screws (3) with a **torque of 9 Nm**; see «Figure 6-2».
16. Connect electrical power supply.
17. Connect compressed air supply.
18. Perform one cycle; see chapter «4.5 Initial operation».

Valve is ready for use.

6.5 Replacement of gate O-ring via actuator flange (actuator up)

	<p style="text-align: center;">⚠ WARNING</p> <p>Heavy weight Physical overstraining. Use a crane to lift the product.</p>
	<p style="text-align: center;">NOTICE</p> <p>Suspended load Product may get damaged when colliding with solid objects. Assistant staff should help each other when carrying out the work.</p>
	<p style="text-align: center;">NOTICE</p> <p>Contamination Product may get contaminated. Always wear cleanroom gloves when handling the product.</p>
	<p style="text-align: center;">NOTICE</p> <p>Inappropriate tools Sealing surfaces may get damaged. Do not use sharp-edged tools.</p>

1. Set valve to service position 2.
2. Vent both chambers and valve body.
3. Disconnect main compressed air supply and keep the air tubes between solenoid valves and actuator connected.
4. Disconnect electrical power supply.
5. Fasten lifting ropes at the lifting points; see «Figure 6-4» on page 32.
6. Remove screws (3) with an allen wrench size 5 from actuator flange (5); see «Figure 6-4» on page 32.
7. Lift valve insert (7) by using a crane or lifting device; see «Figure 6-4» on page 32.

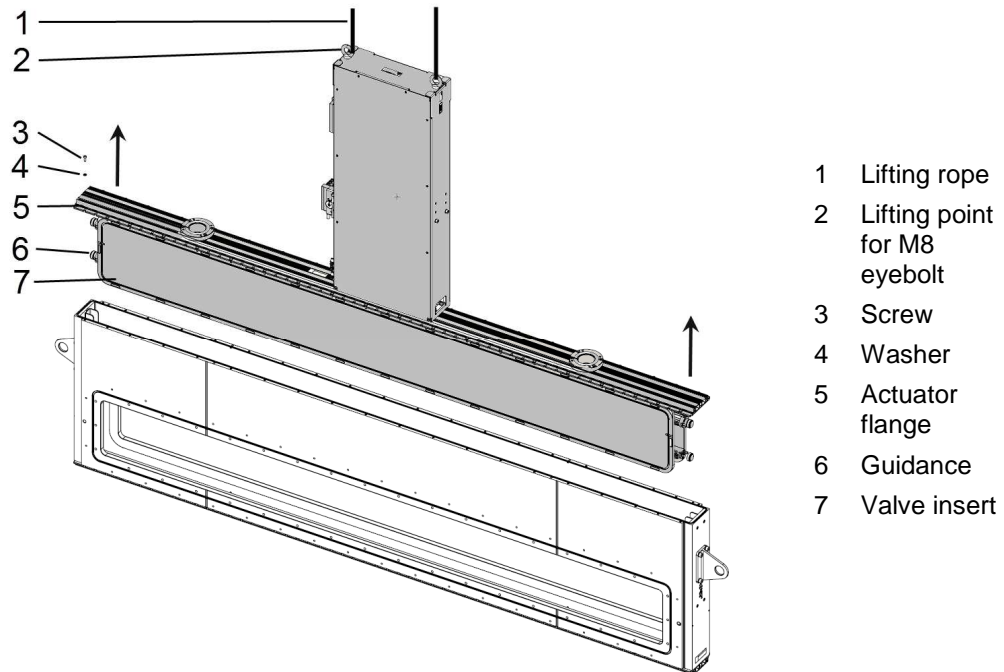





Figure 6-4

8. Place valve insert on an even and clean surface.
9. Clean 4x guidance (6) if required.
10. Perform steps 9 to 14 in chapter «6.4 Replacement of gate O-ring via actuator Flange».
11. Tighten screws (1) with a **torque of 9 Nm**; see «Figure 6-4».
12. Perform steps 16 to 18 in chapter «6.4 Replacement of gate O-ring via actuator Flange».

Valve is ready for use.

6.6 Replacement of gate via actuator flange (actuator down)

	<p style="text-align: center;">⚠ WARNING</p> <p>Heavy weight Physical overstraining. Use a crane to lift the product.</p>
	<p style="text-align: center;">NOTICE</p> <p>Suspended load Product may get damaged when colliding with solid objects. Assistant staff should help each other when carrying out the work.</p>
	<p style="text-align: center;">NOTICE</p> <p>Contamination Product may get contaminated. Always wear cleanroom gloves when handling the product.</p>
	<p style="text-align: center;">NOTICE</p> <p>Inappropriate tools Sealing surfaces may get damaged. Do not use sharp-edged tools.</p>

1. Perform steps 1 to 7 in chapter «6.4 Replacement of gate O-ring via actuator flange (actuator down)».
2. Turn gate fixation (1) with a screw driver by 90°; see «Figure 6-5» on page 34.

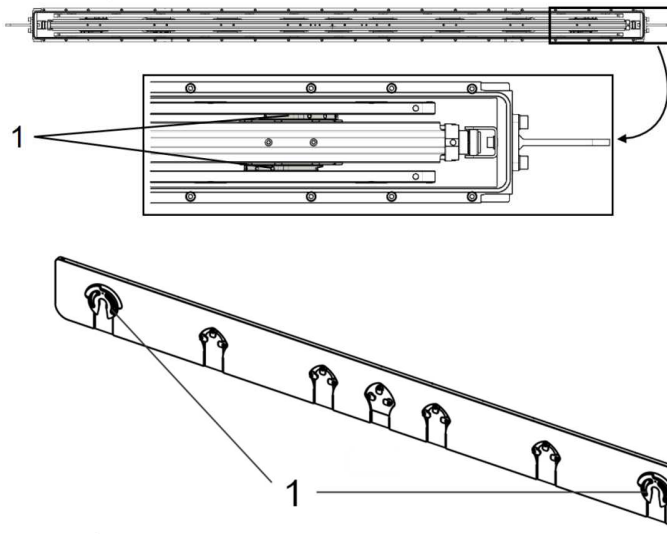

1 Gate fixation

Figure 6-5

3. Remove gate (2); see «Figure 6-6».

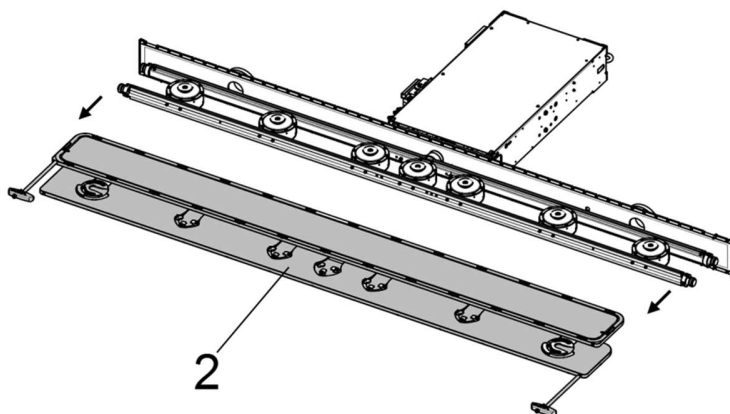

2 Gate

Figure 6-6

4. Reassemble the valve with a new gate







VAT recommends replacing the screws on the actuator flange; see chapter «11 Spare parts».

5. Tighten screws (3) with a **torque of 9 Nm**; see «Figure 6-2» on page 29.
6. Connect electrical power supply.
7. Connect compressed air supply.
8. Perform one cycle; see chapter «4.5 Initial operation».

Valve is ready for use.

6.7 Replacement of gate via actuator flange (actuator up)

	<p style="text-align: center;">⚠ WARNING</p> <p>Heavy weight Physical overstraining. Use a crane to lift the product.</p>
	<p style="text-align: center;">NOTICE</p> <p>Suspended load Product may get damaged when colliding with solid objects. Assistant staff should help each other when carrying out the work.</p>
	<p style="text-align: center;">NOTICE</p> <p>Contamination Product may get contaminated. Always wear cleanroom gloves when handling the product.</p>
	<p style="text-align: center;">NOTICE</p> <p>Inappropriate tools Sealing surfaces may get damaged. Do not use sharp-edged tools.</p>

1. Set valve to service position 1.
2. Vent both chambers and valve body.
3. Disconnect compressed air supply.
4. Disconnect electrical power supply.
5. Fasten lifting ropes (1) at the lifting points (2); see «Figure 6-7» on page 36.
6. Remove screws (3) with an allen wrench size 5 from actuator flange (5); see «Figure 6-7» on page 36.
7. Lift valve insert (7) by using a crane; see «Figure 6-7».

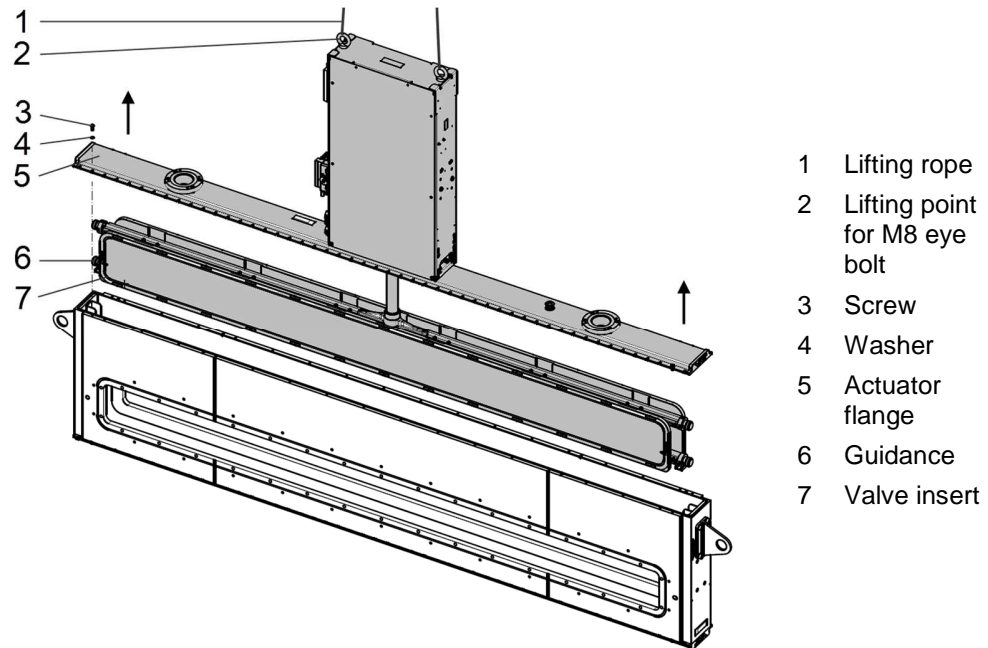

Figure 6-7

8. Place valve insert on an even and clean surface.
9. Turn gate fixation (1) with a screw driver by 90°; see «Figure 6-8» on page 37.

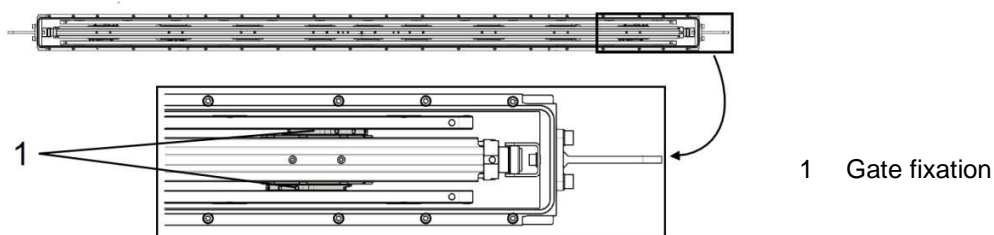

Figure 6-8

10. Remove gate (2); see «Figure 6-9».

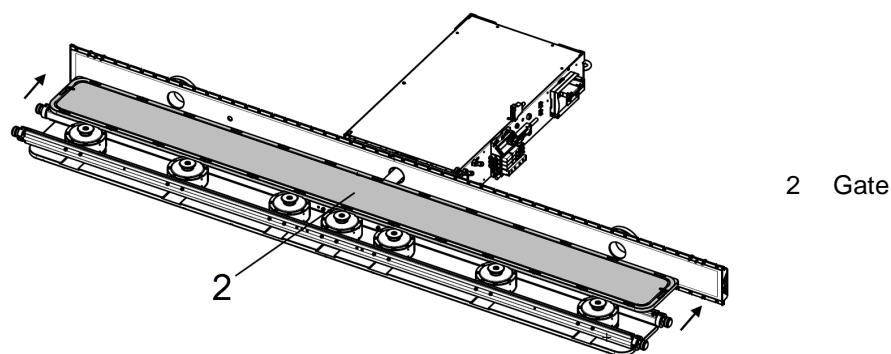

Figure 6-9

11. Clean 4x guidance (6) if required
 12. Reassemble the valve with a new gate by using the convenience tool.



VAT recommends replacing the screws on the actuator flange and / or body cover; see chapter «11 Spare parts».

13. Tighten screws (3) with a **torque of 9 Nm**; see «Figure 6-7» on page 36.
 14. Connect electrical power supply.
 15. Connect compressed air supply.
 16. Perform one cycle; see chapter «4.5 Initial operation».





Valve is ready for use.

7 Repairs

Repairs may only be carried out by the VAT service staff. In exceptional cases, the customer is allowed to carry out the repairs, but only with the prior consent of VAT.

Please contact one of our service centers. You will find the addresses on our website www.vatvalve.com.

8 Dismounting and Storage

	<p style="text-align: center;">⚠ WARNING</p> <p>Unqualified personnel Inappropriate handling may cause serious injury or property damage. Only qualified personnel are allowed to carry out the described work.</p>
	<p style="text-align: center;">⚠ WARNING</p> <p>Heavy weight Physical overstraining. Use a crane to lift the product.</p>
	<p style="text-align: center;">⚠ WARNING</p> <p>Hazardous components Parts, loaded springs, air cushions etc. may move or release a movement and cause serious injury. Before dismantling the product</p> <ul style="list-style-type: none"> – disconnect compressed air supply – disconnect electrical power supply
	<p style="text-align: center;">⚠ WARNING</p> <p>Movable parts Human body parts may get jammed and severely injured. Keep human body parts away from movable parts.</p>
	<p style="text-align: center;">NOTICE</p> <p>Contamination Product may get contaminated. Always wear cleanroom gloves when handling the product.</p>

8.1 Dismounting

	NOTICE
	<p>Valve in closed position</p> <p>Valve body and valve gate will get damaged if valve gate is in closed position. Open valve before dismounting it from the system.</p>

1. Open valve.
2. For dismounting the valve follow the steps of chapter «4 Installation», however in reverse order.



Follow the safety instructions of chapter «4 Installation».

8.2 Storage

	NOTICE
	<p>Wrong storage</p> <p>Inappropriate temperatures and humidity may cause damage to the product. Valve must be stored at:</p> <ul style="list-style-type: none"> – relative humidity between 10% and 70% – temperature between +10 °C and +50 °C – non-condensing environment

	NOTICE
	<p>Inappropriate packaging</p> <p>Product may get damaged if inappropriate packaging material is used. Always use the original packaging material and handle product with care.</p>

1. Clean / decontaminate valve.
2. Attach transportation safety device.
3. Cover all valve openings with a protective foil.
4. Pack valve appropriately, by using the original packaging material.

9 Packaging and Transport

	<p style="text-align: center;">⚠ WARNING</p> <p>Unqualified personnel Inappropriate handling may cause serious injury or property damage. Only qualified personnel are allowed to carry out the described work.</p>
	<p style="text-align: center;">⚠ WARNING</p> <p>Heavy weight Physical overstraining. Use a crane to lift the product.</p>
	<p style="text-align: center;">⚠ WARNING</p> <p>Harmful substances Risk of injury in case of contact with harmful substances. Insure that the substances on the valve body do not react with the packaging materials. Remove harmful substances (e. g. toxic, caustic or microbiological ones) from valve before you return the valve to VAT.</p>
	<p style="text-align: center;">NOTICE</p> <p>Inappropriate packaging Product may get damaged if inappropriate packaging material is used. Always use the original packaging material and handle product with care.</p>



- When returning products to VAT, please fill out the VAT form «Declaration of Chemical Contamination» and send it to VAT in advance. The form can be downloaded from our website www.vatvalve.com.
- If products are radioactively contaminated, the VAT form «Contamination and Radiation Report» must be filled out. Please contact VAT in advance.
- If products are sent to VAT in contaminated condition, VAT will carry out the decontamination procedure at the customer's expense.

9.1 Packaging

NOTICE	
	<p>Valve in closed position</p> <p>Valve body and valve gate will get damaged if valve gate is in closed position. Make sure that the valve is opened.</p>

1. Attach transportation safety device.
2. Cover all valve openings with a protective foil.
3. Pack valve appropriately, by using the original packaging material from VAT as far as the valve and environmental conditions allow this.



VAT disclaims any liability for damages resulting from inappropriate packaging.



9.2 Transport

NOTICE	
	<p>Inappropriate packaging</p> <p>Product may get damaged if inappropriate packaging material is used. Always use the original packaging material and handle product with care.</p>



VAT disclaims any liability for damages resulting from inappropriate packaging.

10 Disposal

	 WARNING
	<p>Harmful substances Environmental pollution. Discard products and parts according to the local regulations.</p>

11 Spare parts

	NOTICE
<p>Non-original spare parts Non-original spare parts may cause damage to the product. Use original spare parts from VAT only.</p>	



- Please specify the fabrication number of the product when you place an order for spare parts; see chapter «1.1 Identification of product». This is to ensure that the appropriate spare parts are supplied.
- VAT makes a difference between spare parts that may be replaced by the customer and those that need to be replaced by the VAT service staff.
- «Table 11-1» only contains spare parts that may be replaced by the customer. If you need any other spare parts, please contact one of our service centers. You will find the addresses on our website www.vatvalve.com.

Description	Part No.	Quantity per valve	Maintenance procedure see chapter
Gate O-ring	on request	2	«6.4 Replacement of gate O-ring via actuator flange (actuator down)» «6.5 Replacement of gate O-ring via actuator flange (actuator up)»
Gate	on request	2	«6.6 Replacement of gate via actuator flange (actuator down)» «6.7 Replacement of gate via actuator flange (actuator up)»
Screws for actuator flange and body cover	on request	on request	–
Convenience tool	239582 or 424623	2	Not needed for this product configuration.
O-ring removal tool	234859	1	«6.4 Replacement of gate O-ring via actuator flange (actuator down)» «6.5 Replacement of gate O-ring via actuator flange (actuator up)»
Lifting device	254408	2	«4.1 Unpacking»
Gate assembling device	254804	2	Not applicable for this product configuration.

Table 11-1